

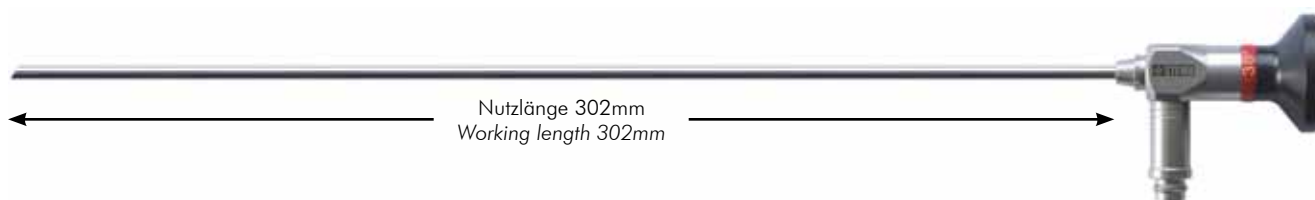

**UROLOGIE**

**UROLOGY**





	<b>Bestell-Nr. Ordering no.</b>	<b>Durchmesser Diameter</b>	<b>Blickrichtung Direction of view</b>	<b>Farbmarkierung Colour code</b>
1	<b>AA-001-001</b>	2.7mm	0°	Grün Green
2	<b>AA-001-002</b>	2.7mm	12°	Weiß White
3	<b>AA-001-003</b>	2.7mm	30°	Rot Red
4	<b>AA-001-004</b>	2.7mm	70°	Gelb Yellow
19	<b>AA-003-001</b>	2.9mm	0°	Grün Green
22	<b>AA-003-004</b>	2.9mm	12°	Weiß White
20	<b>AA-003-002</b>	2.9mm	30°	Rot Red
21	<b>AA-003-003</b>	2.9mm	70°	Gelb Yellow
8	<b>AA-002-001</b>	4.0mm	0°	Grün Green
9	<b>AA-002-001-W</b>	4.0mm	0° - Weitwinkel 0° - Wide angle	Grün Green
10	<b>AA-002-002</b>	4.0mm	12°	Weiß White
11	<b>AA-002-003</b>	4.0mm	30°	Rot Red
12	<b>AA-002-003-W</b>	4.0mm	30° - Weitwinkel 30° - Wide angle	Rot Red
13	<b>AA-002-004</b>	4.0mm	70°	Gelb Yellow
14	<b>AA-002-004-W</b>	4.0mm	70° - Weitwinkel 70° - Wide angle	Gelb Yellow

**STEMA** **High Definition**

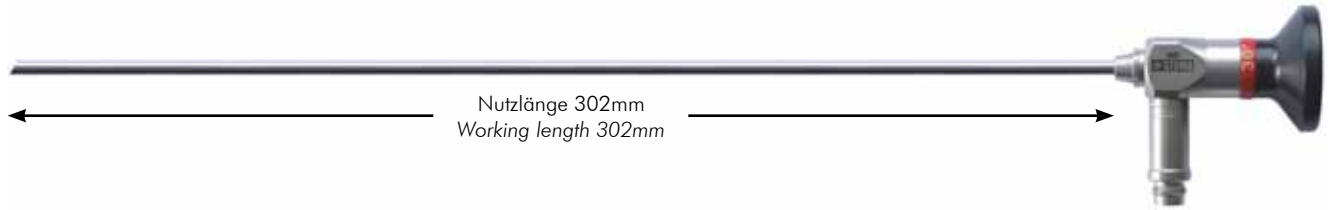

	<b>Bestell-Nr. Ordering no.</b>	<b>Durchmesser Diameter</b>	<b>Blickrichtung Direction of view</b>	<b>Farbmarkierung Colour code</b>
5	<b>AA-001-011</b>	2.7mm	0°	Grün Green
6	<b>AA-001-013</b>	2.7mm	30°	Rot Red
7	<b>AA-001-014</b>	2.7mm	70°	Gelb Yellow
23	<b>AA-003-011</b>	2.9mm	0°	Grün Green
25	<b>AA-003-014</b>	2.9mm	12°	Weiß White
24	<b>AA-003-012</b>	2.9mm	30°	Rot Red
15	<b>AA-002-011</b>	4.0mm	0°	Grün Green
16	<b>AA-002-012</b>	4.0mm	12°	Weiß White
17	<b>AA-002-013</b>	4.0mm	30°	Rot Red
18	<b>AA-002-014</b>	4.0mm	70°	Gelb Yellow



	<b>Bestell-Nr.</b> <b>Ordering no.</b>	<b>Farbmarkierung</b> <b>Colour code</b>	
113	<b>AB-001-002</b>	Gelb Yellow	Cystos-Urethroskopschaft <b>17</b> Charr. mit 2 starren Hähnen, mit Obturator Cysto-Urethroscope sheath <b>17</b> Fr. with 2 fixed stopcock, with obturator
114	<b>AB-001-003</b>	Grün Green	Cystos-Urethroskopschaft <b>19</b> Charr. mit 2 starren Hähnen, mit Obturator Cysto-Urethroscope sheath <b>19</b> Fr. with 2 fixed stopcock, with obturator
115	<b>AB-001-004</b>	Rot Red	Cystos-Urethroskopschaft <b>21</b> Charr. mit 2 starren Hähnen, mit Obturator Cysto-Urethroscope sheath <b>21</b> Fr. with 2 fixed stopcock, with obturator
116	<b>AB-001-005</b>	Blau Blue	Cystos-Urethroskopschaft <b>23</b> Charr. mit 2 starren Hähnen, mit Obturator Cysto-Urethroscope sheath <b>23</b> Fr. with 2 fixed stopcock, with obturator
117	<b>AB-001-006</b>	Weiss White	Cystos-Urethroskopschaft <b>25</b> Charr. mit 2 starren Hähnen, mit Obturator Cysto-Urethroscope sheath <b>25</b> Fr. with 2 fixed stopcock, with obturator



	<b>Bestell-Nr.</b> <b>Ordering no.</b>	<b>Farbmarkierung</b> <b>Colour code</b>	
138	<b>AB-002-001</b>	Gelb Yellow	Cystos-Urethroskopschaft <b>17</b> Charr. mit Zentralthahn, mit Obturator Cysto-Urethroscope sheath <b>17</b> Fr. with central valve, with obturator
139	<b>AB-002-002</b>	Grün Green	Cystos-Urethroskopschaft <b>19</b> Charr. mit Zentralthahn, mit Obturator Cysto-Urethroscope sheath <b>19</b> Fr. with central valve, with obturator
140	<b>AB-002-003</b>	Rot Red	Cystos-Urethroskopschaft <b>21</b> Charr. mit Zentralthahn, mit Obturator Cysto-Urethroscope sheath <b>21</b> Fr. with central valve, with obturator
141	<b>AB-002-004</b>	Blau Blue	Cystos-Urethroskopschaft <b>23</b> Charr. mit Zentralthahn, mit Obturator Cysto-Urethroscope sheath <b>23</b> Fr. with central valve, with obturator
142	<b>AB-002-005</b>	Weiß White	Cystos-Urethroskopschaft <b>25</b> Charr. mit Zentralthahn, mit Obturator Cysto-Urethroscope sheath <b>25</b> Fr. with central valve, with obturator



Alle Schäfte sind auch als „Klick-System“ erhältlich.  
 All sheaths are also available as „Click-System“.





	<b>Bestell-Nr.</b> <b>Ordering no.</b>	<b>Farbmarkierung</b> <b>Colour code</b>	
125	<b>AB-001-012</b>	Gelb Yellow	Standardobturator für Cysto-Urethroskopschäfte <b>17</b> Charr. Standardobturator Cysto-Urethroscope sheath <b>17</b> Fr.
126	<b>AB-001-013</b>	Grün Green	Standardobturator für Cysto-Urethroskopschäfte <b>19</b> Charr. Standardobturator Cysto-Urethroscope sheath <b>19</b> Fr.
127	<b>AB-001-014</b>	Rot Red	Standardobturator für Cysto-Urethroskopschäfte <b>21</b> Charr. Standardobturator Cysto-Urethroscope sheath <b>21</b> Fr.
128	<b>AB-001-015</b>	Blau Blue	Standardobturator für Cysto-Urethroskopschäfte <b>23</b> Charr. Standardobturator Cysto-Urethroscope sheath <b>23</b> Fr.
129	<b>AB-001-016</b>	Weiss White	Standardobturator für Cysto-Urethroskopschäfte <b>25</b> Charr. Standardobturator Cysto-Urethroscope sheath <b>25</b> Fr.



	<b>Bestell-Nr.</b> <b>Ordering no.</b>	<b>Farbmarkierung</b> <b>Colour code</b>	
130	<b>AB-001-022</b>	Gelb Yellow	Sichtobturator für Cysto-Urethroskopschäfte <b>17</b> Charr. Viewing obturator Cysto-Urethroscope sheath <b>17</b> Fr.
131	<b>AB-001-023</b>	Grün Green	Sichtobturator für Cysto-Urethroskopschäfte <b>19</b> Charr. Viewing obturator Cysto-Urethroscope sheath <b>19</b> Fr.
132	<b>AB-001-024</b>	Rot Red	Sichtobturator für Cysto-Urethroskopschäfte <b>21</b> Charr. Viewing obturator Cysto-Urethroscope sheath <b>21</b> Fr.
133	<b>AB-001-025</b>	Blau Blue	Sichtobturator für Cysto-Urethroskopschäfte <b>23</b> Charr. Viewing obturator Cysto-Urethroscope sheath <b>23</b> Fr.
134	<b>AB-001-026</b>	Weiss White	Sichtobturator für Cysto-Urethroskopschäfte <b>25</b> Charr. Viewing obturator Cysto-Urethroscope sheath <b>25</b> Fr.



	<b>Bestell-Nr.</b> <b>Ordering no.</b>	
120	<b>AB-001-010</b>	Cystoskop Adapter für Urethroskopie bei Frauen Cystoscope adaptor for female urethrosopy



**AB-003-002**



**AB-003-003**



**AB-003-004**



**AB-003-015**

**Bestell-Nr.**  
**Ordering no.**

150	<b>AB-003-002</b>	Endoskopbrücke, Diagnose <i>Endoscope bridge, diagnostic</i>
151	<b>AB-003-003</b>	Endoskopbrücke mit 1 Instrumentenkanal <i>Endoscope bridge with 1 instrument channel</i>
152	<b>AB-003-004</b>	Endoskopbrücke mit 2 Instrumentenkanäle <i>Endoscope bridge with 2 instrument channels</i>
163	<b>AB-003-015</b>	Endoskopbrücke mit 2 Instrumentenkanäle, kurz <i>Endoscope bridge with 2 instrument channels, short</i>

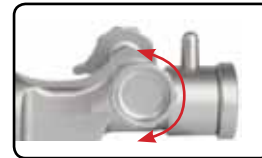
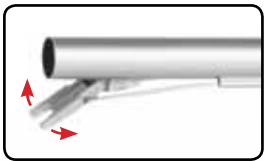

**AB-003-006 /**  
**AB-003-008**

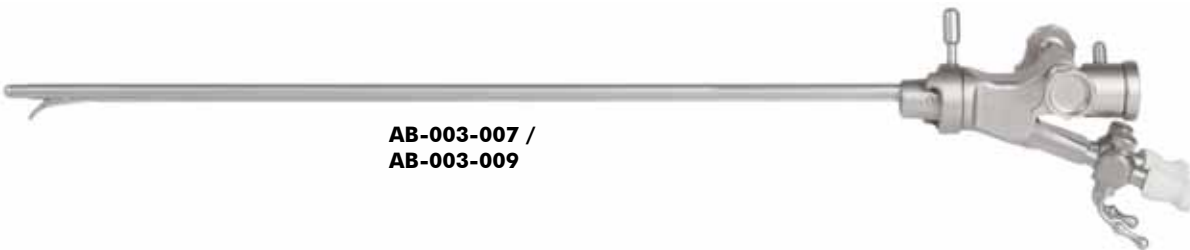

**AB-003-007 /**  
**AB-003-009**

**Bestell-Nr.**  
**Ordering no.**

154	<b>AB-003-006</b>	Arbeitseinsatz mit Albarranhebel und 1 Instrumentenkanal <i>Working element with Albarran deflector and 1 instrument channel</i>
155	<b>AB-003-007</b>	Arbeitseinsatz mit Albarranhebel und 2 Instrumentenkanälen <i>Working element with Albarran deflector and 2 instrument channels</i>
156	<b>AB-003-008</b>	Arbeitseinsatz mit Albarranhebel und 1 Instrumentenkanal, ohne Raste <i>Working element with Albarran deflector and 1 instrument channel, without ratchet</i>
157	<b>AB-003-009</b>	Arbeitseinsatz mit Albarranhebel und 2 Instrumentenkanälen, ohne Raste <i>Working element with Albarran deflector and 2 instrument channels, without ratchet</i>



**Bestell-Nr.**  
**Ordering no.**

<b>AA-002-003</b>	Cystoskop Ø 4.0mm, Blickwinkel 30° autoklavierbar <i>Cystoscope Ø 4.0mm, 30° viewing angle, autoclavable</i>
<b>AA-002-013</b>	<b>HD</b> Cystoskop Ø 4.0mm, Blickwinkel 30° autoklavierbar <b>HD</b> Cystoscope Ø 4.0mm, 30° viewing angle, autoclavable



**Bestell-Nr.**  
**Ordering no.**

**Farbmarkierung**  
**Colour code**

135

<b>AB-001-040</b>	Blau <i>Blue</i>	LASER Cysto-Urethroskopaussenschaft 23 Charr. mit 2 starren Hähnen für 30° Optik <i>LASER Cysto-Urethroscope outer sheath 23 Fr. with 2 fixed stopcock used for 30° endoscope</i>
-------------------	---------------------	--



**Bestell-Nr.**  
**Ordering no.**

**Farbmarkierung**  
**Colour code**

136

<b>AB-001-041</b>	Blau <i>Blue</i>	LASER Cysto-Urethroskopinnenschaft mit 8 Charr. Arbeitskanal <i>LASER Cysto-Urethroscope inner sheath with 8 Fr. working channel</i>
-------------------	---------------------	---

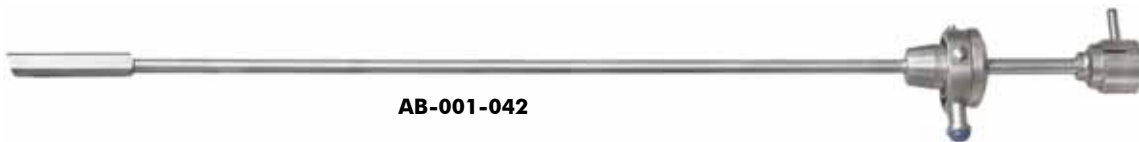

**Bestell-Nr.**  
**Ordering no.**

**Farbmarkierung**  
**Colour code**

137

<b>AB-001-042</b>	Blau <i>Blue</i>	Sichtobturator für Cysto-Urethroskopschaft AB-001-040 <i>Viewing obturator for Cysto-Urethroscope sheath AB-001-040</i>
-------------------	---------------------	--

138

<b>AB-001-043</b>	Blau <i>Blue</i>	Obturator für Cysto-Urethroskopschaft AB-001-040 <i>Obturator for Cysto-Urethroscope sheath AB-001-040</i>
-------------------	---------------------	---



**Bestell-Nr.  
Ordering no.**

**AA-003-002** Cystoskop Ø 2.9mm, Blickwinkel 30°, autoklavierbar  
Cystoscope Ø 2.9mm, 30° viewing angle, autoclavable

**AA-003-012** **HD** Cystoskop Ø 2.9mm, Blickwinkel 30°, autoklavierbar  
**HD** Cystoscope Ø 2.9mm, 30° viewing angle, autoclavable



**Bestell-Nr.  
Ordering no.** **Farbmarkierung  
Colour code**

119

**AB-001-007** Schwarz Black Cysto-Urethroskopschaft 15 Charr. mit 2 starren Hähnen, 5 Charr. Instrumentenkanal, inkl. Obturator  
Cysto-Urethroscope sheath 15 Fr. with 2 fixed stopcock, 5 Fr. instrument channel, incl. obturator



**Bestell-Nr.  
Ordering no.** **Farbmarkierung  
Colour code**

108

**AB-001-000** Schwarz Black Cysto-Urethroskopschaft 16 Charr. mit 2 starren Hähnen, Quick-Lock, inkl. Obturator  
Cysto-Urethroscope sheath 16 Fr. with 2 fixed stopcock, Quick-Lock, incl. obturator





**AB-003-010**

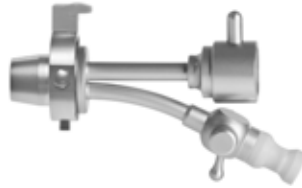

**AB-003-011**



**AB-003-012**

**Bestell-Nr.**  
**Ordering no.**

158	<b>AB-003-010</b>	Endoskopbrücke, Diagnose für 16 Charr. Schaft <i>Endoscope bridge, diagnostic used for 16 Fr. sheath</i>
159	<b>AB-003-011</b>	Endoskopbrücke mit 1 Instrumentenkanal für 16 Charr. Schaft <i>Endoscope bridge with 1 instrument channel used for 16 Fr. sheath</i>
160	<b>AB-003-012</b>	Endoskopbrücke mit 2 Instrumentenkanälen für 16 Charr. Schaft <i>Endoscope bridge with 2 instrument channels used for 16 Fr. sheath</i>

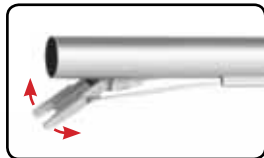

**AB-003-013**

**Bestell-Nr.**  
**Ordering no.**

161	<b>AB-003-013</b>	Arbeitseinsatz mit Albarranhebel und 1 Instrumentenkanal für 16 Charr. Schaft, Quick-Lock <i>Working element with Albarran deflector and 1 instrument channel used for 16 Fr. sheath</i>
162	<b>AB-003-014</b>	Arbeitseinsatz mit Albarranhebel und 2 Instrumentenkanälen für 16 Charr. Schaft <i>Working element with Albarran deflector and 2 instrument channels used for 16 Fr. sheath</i>



**Bestell-Nr.**  
**Ordering no.**

<b>AB-003-020</b>	Füllstab für Arbeitseinsätze mit Albarranhebel <i>Protective rod for working elements with Albarran deflector</i>
-------------------	--

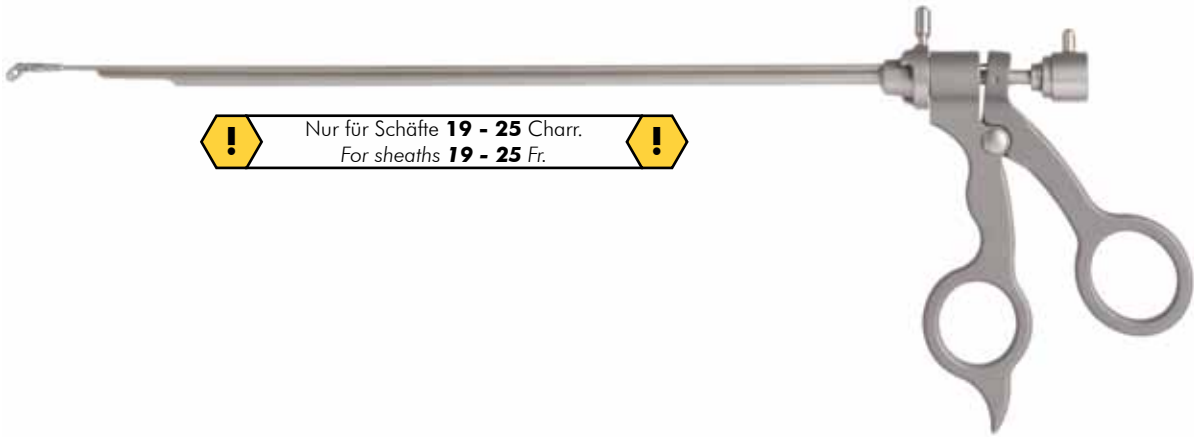



! Nur für Schäfte **19 - 25** Charr.  
For sheaths **19 - 25** Fr. !

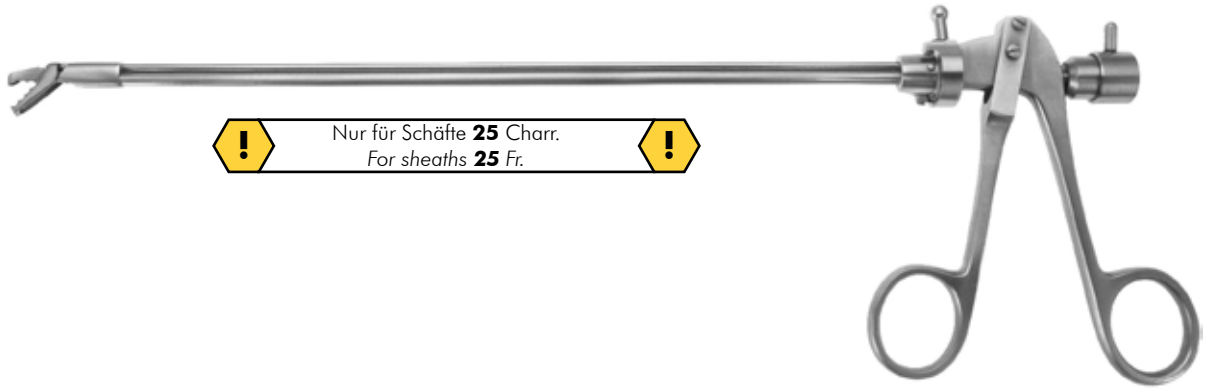







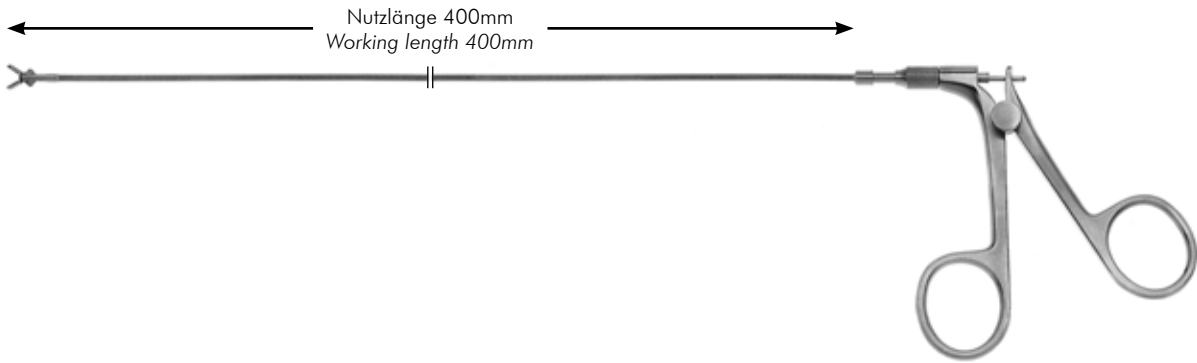



	<b>Bestell-Nr.</b> <b>Ordering no.</b>	<b>Für Optiken</b> <b>For scopes</b>	
	<b>AB-004-005</b> 168	12° / 30°	Biopsiefäßzange (unten), doppelbeweglich Biopsy forceps (down), double action
	<b>AB-004-006</b> 169	70°	Biopsiefäßzange (unten), doppelbeweglich Biopsy forceps (down), double action
	<b>AB-004-001</b> 164	0° / 12° / 30°	Probeexzisionszange, doppelbeweglich Biopsy forceps, double action
	<b>AB-004-002</b> 165	0° / 12°	Probeexzisionszange, durchschneidend Biopsy forceps, through cutting
	<b>AB-004-004</b> 167	0° / 12°	Hakenschere, doppelbeweglich Hook scissors, double action
	<b>AB-004-010</b> 174	0° / 12°	Faßzange, beidseitig öffnend, zur Entfernung von Stents Forceps, double action, for removal fo stents
	<b>AB-004-003</b> 166	0° / 12°	Fasszange, doppelbeweglich Grasping forceps, double action
	<b>AB-004-008</b> 171		Adapter für den Einsatz mit Resektoskopschäften Adapter for use with resectoscope sheaths







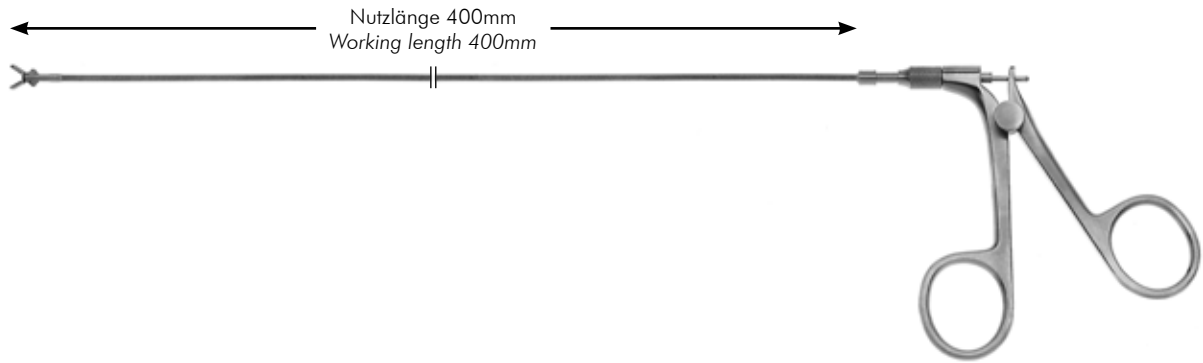

**!** Nur für Schäfte **25** Charr.  
For sheaths **25** Fr. **!**

	<b>Bestell-Nr.</b> <b>Ordering no.</b>	<b>Für Optiken</b> <b>For scopes</b>	
	<b>AB-004-007</b> 170	0° / 12° / 30°	Optische Steinzange <i>Optical stone punch</i>
	<b>AB-004-009</b> 172		Adapter für den Einsatz mit Resektoskopschäften 26 - 28.5 Charr. <i>Adaptor for use with resectoscope sheaths 26 - 28.5 Fr.</i>
	<b>AB-004-009-QL</b> 173		Adapter für den Einsatz mit Resektoskopschäften 26 - 28.5 Charr. STEMA Click-System <i>Adaptor for use with resectoscope sheaths 26 - 28.5 Fr.</i> STEMA Click-System









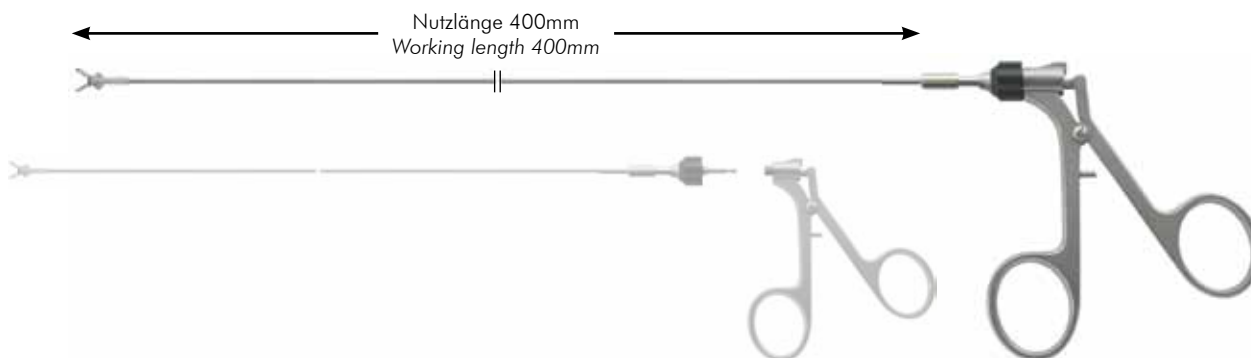



		Ømm	Charr. Fr.	Flexibel Flexible	Halbstarr Semi-rigid	Starr Rigid
	Probeexzisionszange oval, doppelbeweglich <i>Biopsy forceps oval, double action</i>	1.0	3	235	AC-001-001276	AC-001-001-R 237
		1.6	5	239	AC-001-002279	AC-001-002-R 241
		2.1	6	243	AC-001-003282	AC-001-003-R 244
		2.3	7	245	AC-001-004285	AC-001-004-R 247
		3.0	9	249	AC-001-005288	AC-001-005-R 251
	Probeexzisionszange oval, gezahnt, doppelbeweglich <i>Biopsy forceps oval, serrated, double action</i>	1.0	3	249	AC-002-001	AC-002-001-R
		1.6	5	311	AC-002-002326	AC-002-002-R 312
		2.1	6	313	AC-002-003327	AC-002-003-R
		2.3	7	314	AC-002-004328	AC-002-004-R 315
	Probeexzisionszange oval, gezahnt, Zähne ineinandergreifend, doppelbeweglich <i>Biopsy forceps oval, serrated, teeth interlock, double action</i>	1.6	5	588	AC-015-002599	AC-015-002-R 589
		2.1	6	590	AC-015-003600	AC-015-003-R
		2.3	7	591	AC-015-004601	AC-015-004-R 592
	Fremdkörperzange, doppelbeweglich <i>Grasping forceps for stone street, double action</i>	1.2	4	624	AC-017-001632	AC-017-001-R 625
		2.3	7	626	AC-017-004633	AC-017-004-R 627
	Fasszange Alligatormaul, doppelbeweglich <i>Grasping forceps alligator jaw, double action</i>	1.0	3	445	AC-006-001486	AC-006-001-R 447
		1.2	4	453	AC-006-003492	AC-006-003-R 455
		1.6	5	449	AC-006-002489	AC-006-002-R 451
		2.3	7	457	AC-006-004495	AC-006-004-R 459
		3.0	9	461	AC-006-005498	AC-006-005-R 463
	Fasszange DJ, doppelbeweglich <i>Grasping forceps DJ, double action</i>	2.3	7	549	AC-008-004554	AC-008-004-R 550
		3.0	9	551	AC-008-005555	AC-008-005-R
	Fasszange gezahnt, doppelbeweglich <i>Grasping forceps teeth, double action</i>	1.2	4	606	AC-016-001	AC-016-201 AC-016-001-R 608
		1.6	5	610	AC-016-002	AC-016-202 AC-016-002-R 612
	Fasszange Zähne ineinander, doppelbeweglich <i>Grasping forceps teeth interlock, double action</i>	1.6	5	656	AC-020-002664	AC-020-002-R 657
		2.3	7	658	AC-020-004665	AC-020-004-R 659
	Fasszange Rattenzahn, doppelbeweglich <i>Grasping forceps rat tooth, double action</i>	1.0	3	639	AC-019-001651	AC-019-001-R 641
		1.6	5	643	AC-019-002652	AC-019-002-R 645
	Fasszange für Steinstrasse, doppelbeweglich <i>Grasping forceps for stone street, double action</i>	1.2	4	521	AC-007-001537	AC-007-201 AC-007-001-R 523
		1.6	5	525	AC-007-002540	AC-007-202 AC-007-002-R 527
	Fasszange für große Steine, doppelbeweglich <i>Grasping forceps for big stones, double action</i>	1.2	4		AC-009-001	AC-009-201 AC-009-001-R
		1.6	5	558	AC-009-002565	AC-009-202 AC-009-002-R 559
		2.3	7	560	AC-009-004566	AC-009-204 AC-009-004-R 561
	Dreiarmsgreifer mit Griff <i>3-Prongs retriever with handle</i>	1.0	3	570	AC-012-001	AC-012-201 AC-012-001-R
		1.6	5	571	AC-012-002	AC-012-202 AC-012-002-R
		2.3	7	572	AC-012-004	AC-012-204 AC-012-004-R









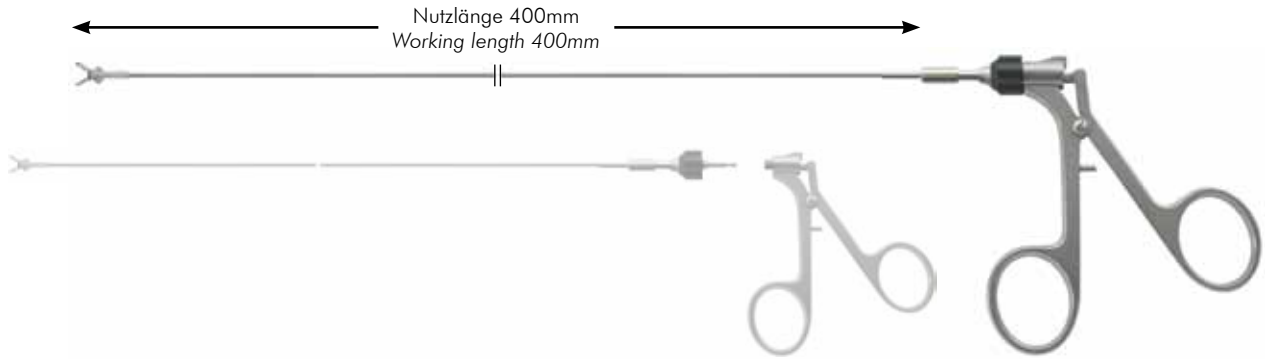

		Ømm	Charr. Fr.	Flexibel Flexible	Halbstarr Semi-rigid	Starr Rigid
	Schere gezahnt, doppelbeweglich Scissors serrated flexible, double action	2.3	7 439	AC-005-004443	AC-005-204	AC-005-004-R 440
	Schere, einfachbeweglich Scissors, single action	1.0	3 334	AC-003-000377	AC-003-200	AC-003-000-R 336
		1.2	4 338	AC-003-001380	AC-003-201	AC-003-001-R 340
		1.6	5 342	AC-003-002383	AC-003-202	AC-003-002-R 343
		2.1	6 244	AC-003-003386	AC-003-203	AC-003-003-R 345
		2.3	7 346	AC-003-004387	AC-003-204	AC-003-004-R 348
3.0	9 350	AC-003-005390	AC-003-205	AC-003-005-R 352		
	Ureter-Schlitzschere, einfachbeweglich Uretero slitting scissors, single action	1.2	4		AC-018-201	AC-018-001-R
		1.6	5		AC-018-202	AC-018-002-R
	Schere spitz, einfachbeweglich Scissors pointed, single action	1.6	5	409	AC-003-302	
		2.3	7	410	AC-003-304	
	Hakenschere, einfachbeweglich Hook scissors, single action	2.3	7 427	AC-004-004435	AC-004-204428	AC-004-004-R
		3.0	9 429	AC-004-005436	AC-004-205430	AC-004-005-R









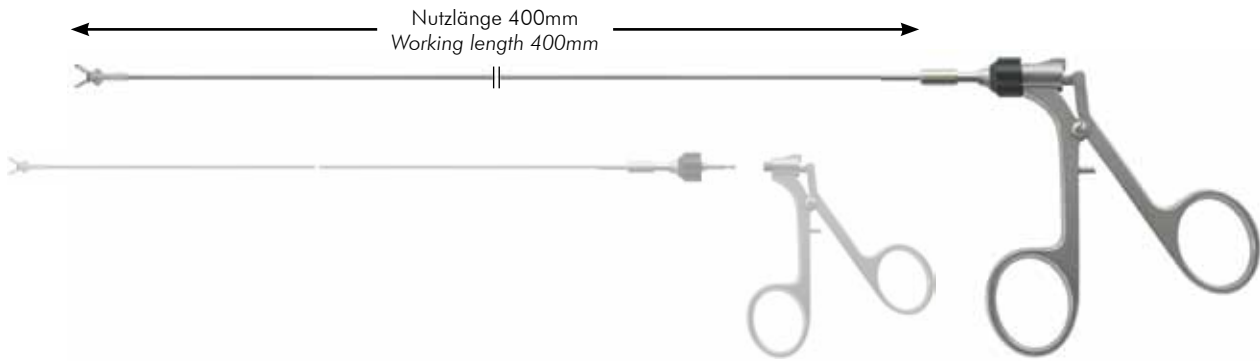

		Ømm	Charr. Fr.	Komplett Complete	Einsatz Insert	Griff Handle
 Probeexzisionszange oval, doppelbeweglich <i>Biopsy forceps oval, double action</i>	1.0	3	238	AC-001-001-T236	AC-001-001-OT	AC-100-001
	1.2	4	254	AC-001-006-T253	AC-001-006-OT	
	1.6	5	242	AC-001-002-T240	AC-001-002-OT	
	2.3	7	248	AC-001-004-T246	AC-001-004-OT	
	3.0	9		AC-001-005-T250	AC-001-005-OT	
 Probeexzisionszange oval, gezahnt, doppelbeweglich <i>Biopsy forceps oval, serrated, double action</i>	1.2	4	609	AC-016-001-T607	AC-016-001-OT	AC-100-001
	1.6	5	613	AC-016-002-T611	AC-016-002-OT	
 Fasszange Alligatormaul, doppelbeweglich <i>Grasping forceps alligator jaw, double action</i>	1.0	3	448	AC-006-001-T446	AC-006-001-OT	AC-100-001
	1.2	4	456	AC-006-003-T454	AC-006-003-OT	
	1.6	5	452	AC-006-002-T450	AC-006-002-OT	
	2.3	7	460	AC-006-004-T458	AC-006-004-OT	
	3.0	9	464	AC-006-005-T462	AC-006-005-OT	
 Fasszange für Steinstrasse, doppelbeweglich <i>Grasping forceps for stone street, double action</i>	1.2	4	524	AC-007-001-T522	AC-007-001-OT	AC-100-001
	1.6	5	528	AC-007-002-T526	AC-007-002-OT	
 Fasszange Rattenzahn, doppelbeweglich <i>Grasping forceps rat tooth, double action</i>	1.0	3	642	AC-019-001-T640	AC-019-001-OT	AC-100-001
	1.2	4	638	AC-019-000-T637	AC-019-000-OT	
	1.6	5	234	AC-019-002-T644	AC-019-002-OT	
 Fasszange für große Steine, doppelbeweglich <i>Grasping forceps for big stones, double action</i>	1.2	4		AC-009-001-T	AC-009-001-OT	AC-100-001
	1.6	5		AC-009-002-T	AC-009-002-OT	
 Schere, einfachbeweglich <i>Scissors, single action</i>	1.0	3	337	AC-003-000-T335	AC-003-000-OT	AC-100-001
	1.2	4	341	AC-003-001-T339	AC-003-001-OT	
	1.6	5		AC-003-002-T	AC-003-002-OT	
	2.3	7	349	AC-003-004-T347	AC-003-004-OT	
	3.0	9	353	AC-003-005-T351	AC-003-005-OT	
 Schere spitz, einfachbeweglich <i>Scissors pointed, single action</i>	1.6	5	412	AC-003-402-T411	AC-003-402-OT	AC-100-001
 Hakenschere, einfachbeweglich <i>Hook scissors, single action</i>	2.3	7		AC-004-004-T	AC-004-004-OT	AC-100-001
	3.0	9		AC-004-005-T	AC-004-005-OT	
 Biopsiestanze, einfachbeweglich <i>Biopsy punch forceps, single action</i>	1.6	5	577	AC-014-002-T576	AC-014-002-OT	AC-100-001



		Ømm	Charr. Fr.	Komplett Complete	Einsatz Insert	Griff Handle
 Probeexzisionszange oval, doppelbeweglich <i>Biopsy forceps oval, double action</i>	1.0	3	278	AC-001-201-T277	AC-001-201-OT	AC-100-001
	1.2	4	290	AC-001-206-T289	AC-001-206-OT	
	1.6	5	281	AC-001-202-T280	AC-001-202-OT	
	2.3	7	284	AC-001-203-T283	AC-001-203-OT	
	3.0	9	287	AC-001-204-T286	AC-001-204-OT	
 Fasszange Alligatormaul, doppelbeweglich <i>Grasping forceps alligator jaw, double action</i>	1.0	3	488	AC-006-201-T487	AC-006-201-OT	AC-100-001
	1.2	4	494	AC-006-203-T493	AC-006-203-OT	
	1.6	5	491	AC-006-202-T490	AC-006-202-OT	
	2.3	7	497	AC-006-204-T496	AC-006-204-OT	
	3.0	9	500	AC-006-205-T499	AC-006-205-OT	
 Fasszange für Steinstrasse, doppelbeweglich <i>Grasping forceps for stone street, double action</i>	1.2	4	539	AC-007-201-T538	AC-007-201-OT	AC-100-001
	1.6	5	542	AC-007-202-T541	AC-007-202-OT	
 Fasszange für große Steine, doppelbeweglich <i>Grasping forceps for big stones, double action</i>	1.2	4		AC-009-201-T	AC-009-201-OT	AC-100-001
 Schere, einfachbeweglich <i>Scissors, single action</i>	1.0	3	379	AC-003-200-T378	AC-003-200-OT	AC-100-001
	1.2	4	382	AC-003-201-T381	AC-003-201-OT	
	1.6	5	385	AC-003-202-T384	AC-003-202-OT	
	2.3	7	389	AC-003-204-T388	AC-003-204-OT	
	3.0	9	392	AC-003-205-T391	AC-003-205-OT	
 Schere spitz, einfachbeweglich <i>Scissors pointed, single action</i>	1.6	5	423	AC-003-612-T422	AC-003-612-OT	AC-100-001
	2.3	7	426	AC-003-614-T425	AC-003-614-OT	
 Hakenschere, einfachbeweglich <i>Hook scissors, single action</i>	2.3	7		AC-004-204-T	AC-204-004-OT	AC-100-001
	3.0	9		AC-004-205-T	AC-004-205-OT	
 Biopsiestanze, einfachbeweglich <i>Biopsy punch forceps, single action</i>	1.6	5	581	AC-014-202-T580	AC-014-202-OT	AC-100-001





		Ømm	Charr. Fr.	Komplett Complete	Einsatz Insert	Griff Handle
 <p>Probeexzisionszange oval, doppelbeweglich <i>Biopsy forceps oval, double action</i></p>	1.0	3	669	AC-101-201-T668	AC-101-201-OT	AC-100-001
	1.2	4	677	AC-101-206-T676	AC-101-206-OT	
	1.6	5	671	AC-101-202-T670	AC-101-202-OT	
	2.3	7	673	AC-101-203-T672	AC-101-203-OT	
	3.0	9	675	AC-101-204-T674	AC-101-204-OT	
 <p>Fasszange Alligatormaul, doppelbeweglich <i>Grasping forceps alligator jaw, double action</i></p>	1.0	3	713	AC-106-201-T	AC-006-201-OT	AC-100-001
	1.2	4	716	AC-106-203-T	AC-006-203-OT	
	1.6	5	714	AC-106-202-T715	AC-006-202-OT	
	2.3	7	718	AC-106-204-T717	AC-006-204-OT	
	3.0	9	720	AC-106-205-T719	AC-006-205-OT	
 <p>Fasszange für Steinstrasse, doppelbeweglich <i>Grasping forceps for stone street, double action</i></p>	1.2	4	732	AC-107-201-T731	AC-107-201-OT	AC-100-001
	1.6	5	734	AC-107-202-T733	AC-107-202-OT	
 <p>Fasszange für große Steine, doppelbeweglich <i>Grasping forceps for big stones, double action</i></p>	1.2	4	740	AC-109-201-T739	AC-109-201-OT	AC-100-001
 <p>Schere, einfachbeweglich <i>Scissors, single action</i></p>	1.0	3		AC-103-200-T	AC-103-200-OT	AC-100-001
	1.2	4	687	AC-103-201-T686	AC-103-201-OT	
	1.6	5	689	AC-103-202-T688	AC-103-202-OT	
	2.3	7	691	AC-103-204-T690	AC-103-204-OT	
	3.0	9	693	AC-103-205-T692	AC-103-205-OT	
 <p>Schere spitz, einfachbeweglich <i>Scissors pointed, single action</i></p>	1.6	5	705	AC-103-612-T704	AC-103-612-OT	AC-100-001
	2.3	7	707	AC-103-614-T706	AC-103-614-OT	
 <p>Hakenschere, einfachbeweglich <i>Hook scissors, single action</i></p>	2.3	7		AC-104-204-T708	AC-104-204-OT	AC-100-001
	3.0	9		AC-104-205-T709	AC-104-205-OT	
 <p>Biopsiestanze, einfachbeweglich <i>Biopsy punch forceps, single action</i></p>	1.6	5	744	AC-114-202-T743	AC-114-202-OT	AC-100-001





	<b>Bestell-Nr.</b> <b>Ordering no.</b>	<b>Drähte</b> <b>Wires</b>	<b>Charr.</b> <b>Fr.</b>	
870	<b>AF-001-002</b>	4	3	Dormia Steinfänger <b>komplett</b> mit Griff, Arbeitslänge 60cm <i>Dormia stone extractor <b>complete</b> with handle, working length 60cm</i>
869	<b>AF-001-001</b>	4	3	Dormia Steinfänger, <b>Körbchen mit Tubus</b> , Arbeitslänge 60cm <i>Dormia stone extractor, <b>basket with tubus</b>, working length 60cm</i>
	<b>AF-001-020</b>			<b>Griff für Dormia Steinfänger 3 Charr.</b> <b>Handle for dormia stone extractor 3 Fr.</b>
872	<b>AF-001-004</b>	4	5	Dormia Steinfänger <b>komplett</b> mit Griff, Arbeitslänge 60cm <i>Dormia stone extractor <b>complete</b> with handle, working length 60cm</i>
871	<b>AF-001-003</b>	4	5	Dormia Steinfänger, <b>Körbchen mit Tubus</b> , Arbeitslänge 60cm <i>Dormia stone extractor, <b>basket with tubus</b>, working length 60cm</i>
874	<b>AF-001-006</b>	4	7	Dormia Steinfänger <b>komplett</b> mit Griff, Arbeitslänge 60cm <i>Dormia stone extractor <b>complete</b> with handle, working length 60cm</i>
873	<b>AF-001-005</b>	4	7	Dormia Steinfänger, <b>Körbchen mit Tubus</b> , Arbeitslänge 60cm <i>Dormia stone extractor, <b>basket with tubus</b>, working length 60cm</i>
876	<b>AF-001-008</b>	5	5	Dormia Steinfänger <b>komplett</b> mit Griff, Arbeitslänge 60cm <i>Dormia stone extractor <b>complete</b> with handle, working length 60cm</i>
875	<b>AF-001-007</b>	5	5	Dormia Steinfänger, <b>Körbchen mit Tubus</b> , Arbeitslänge 60cm <i>Dormia stone extractor, <b>basket with tubus</b>, working length 60cm</i>
878	<b>AF-001-010</b>	5	7	Dormia Steinfänger <b>komplett</b> mit Griff, Arbeitslänge 60cm <i>Dormia stone extractor <b>complete</b> with handle, working length 60cm</i>
877	<b>AF-001-009</b>	5	7	Dormia Steinfänger, <b>Körbchen mit Tubus</b> , Arbeitslänge 60cm <i>Dormia stone extractor, <b>basket with tubus</b>, working length 60cm</i>
880	<b>AF-001-012</b>	6	5	Dormia Steinfänger <b>komplett</b> mit Griff, Arbeitslänge 60cm <i>Dormia stone extractor <b>complete</b> with handle, working length 60cm</i>
879	<b>AF-001-011</b>	6	5	Dormia Steinfänger, <b>Körbchen mit Tubus</b> , Arbeitslänge 60cm <i>Dormia stone extractor, <b>basket with tubus</b>, working length 60cm</i>
882	<b>AF-001-014</b>	6	7	Dormia Steinfänger <b>komplett</b> mit Griff, Arbeitslänge 60cm <i>Dormia stone extractor <b>complete</b> with handle, working length 60cm</i>
881	<b>AF-001-013</b>	6	7	Dormia Steinfänger, <b>Körbchen mit Tubus</b> , Arbeitslänge 60cm <i>Dormia stone extractor, <b>basket with tubus</b>, working length 60cm</i>
	<b>AF-001-016</b>	4	3	Dormia Steinfänger <b>komplett</b> mit Griff, Arbeitslänge 90cm <i>Dormia stone extractor <b>complete</b> with handle, working length 90cm</i>
883	<b>AF-001-015</b>	4	3	Dormia Steinfänger, <b>Körbchen mit Tubus</b> , Arbeitslänge 90cm <i>Dormia stone extractor, <b>basket with tubus</b>, working length 90cm</i>
885	<b>AF-001-018</b>	5	5	Dormia Steinfänger <b>komplett</b> mit Griff, Arbeitslänge 90cm <i>Dormia stone extractor <b>complete</b> with handle, working length 90cm</i>
884	<b>AF-001-017</b>	4	5	Dormia Steinfänger, <b>Körbchen mit Tubus</b> , Arbeitslänge 90cm <i>Dormia stone extractor, <b>basket with tubus</b>, working length 90cm</i>
886	<b>AF-001-019</b>	4	5	Dormia Steinfänger <b>komplett</b> mit Griff, Arbeitslänge 90cm <i>Dormia stone extractor <b>complete</b> with handle, working length 90cm</i>
887	<b>AF-001-021</b>			<b>Griff für Dormia Steinfänger 5 und 7 Charr.</b> <b>Handle for dormia stone extractor 5 and 7 Fr.</b>



Sonderlängen auf Anfrage erhältlich.  
*Special lengths available on request.*





	Bestell-Nr. Ordering no.	Länge Length	Bestell-Nr. Ordering no.	Länge Length	Charr. Fr.	
	AD-003-003	530mm	AD-003-013	650mm	5	Schlingen-Elektrode flexibel, monop. <i>Loop electrode flexible, monopolar</i>
	AD-003-005	4 530mm	AD-003-015	778 650mm	7	
	AD-003-007	77 530mm	AD-003-017	779 650mm	9	
	AD-003-008	50 530mm	AD-003-018	780 650mm	10	Nadel-Elektrode flexibel, monopolar <i>Needle electrode flexible, monopolar</i>
	AD-002-001	6 530mm	AD-002-011	769 650mm	3	
	AD-002-002	6 530mm	AD-002-012	770 650mm	4	
	AD-002-003	76 530mm	AD-002-013	771 650mm	5	Knopf-Elektrode flexibel, monopolar <i>Button electrode flexible, monopolar</i>
	AD-002-005	7 530mm	AD-002-015	772 650mm	7	
	AD-001-001	7 530mm	AD-001-011	757 650mm	3	
	AD-001-002	75 530mm	AD-001-012	758 650mm	4	
	AD-001-003	2 530mm	AD-001-013	759 650mm	5	
	AD-001-004	75 530mm	AD-001-014	760 650mm	6	
	AD-001-005	75 530mm	AD-001-015	761 650mm	7	
	AD-001-006	3 530mm	AD-001-016	762 650mm	8	
AD-001-007	75 530mm	AD-001-017	763 650mm	9		
	AD-001-008	1 530mm	AD-001-018	764 650mm	10	

Anschluss Instrumentenseite <i>Connection instrument side</i>	Anschluss Geräteseite <i>Connection unit side</i>
	AD-010-001 / AD-010-006
	AD-010-002 / AD-010-007
	AD-010-003 / AD-010-008
	AD-010-004 / AD-010-005
	AD-010-021
	AD-010-024

Alle Kabel passen zu den flexiblen Elektroden AD-001-001 bis AD-003-018  
*All cables fit with the flexible electrodes AD-001-001 to AD-003-018*

Bestell-Nr. Ordering no.	Länge Length	
AD-010-001	3m	Monopolares Anschlusskabel für <b>Bertchold, Martin, Aesculap</b> , Ø 4mm
AD-010-006	5m	Monopolar connecting cable for <b>Bertchold, Martin, Aesculap</b> , Ø 4mm
AD-010-002	3m	Monopolares Anschlusskabel für <b>Erbe, ACC/ICC, Storz</b> , Ø 5mm
AD-010-007	5m	Monopolar connecting cable for <b>Erbe, ACC/ICC, Storz</b> , Ø 5mm
AD-010-003	3m	Monopolares Anschlusskabel für <b>Valleylab/Comned</b> , Ø 8mm
AD-010-008	5m	Monopolar connecting cable for <b>Valleylab/Comned</b> , Ø 8mm
AD-010-004	3m	Monopolares Anschlusskabel für Geräte mit <b>4mm Bananenstecker</b>
AD-010-005	5m	Monopolar connecting cable for units with <b>4mm banana plug</b>
AD-010-021	4.5m	Monopolares Anschlusskabel für <b>STEMA MASTER</b> Geräte mit <b>SDS-Erkennung</b>
		Monopolar connecting cable for <b>STEMA MASTER</b> units with <b>SDS identification</b>
AD-010-024	4.5m	Monopolares Anschlusskabel für <b>STEMA MASTER</b> Geräte
		Monopolar connecting cable for <b>STEMA MASTER</b> units

## STEMA **High Definition**



**Bestell-Nr.**  
**Ordering no.**

105

**AA-007-060**

Mini HD Kompakt-Cystoskop mit 30° abgewinkeltem Okular, Schaft 9-12 Charr., Blickwinkel 0°,  
Arbeitslänge 220mm, Instrumentenkanal 5 Charr., 3 Luer-Lock Anschlüsse, 40.000 Pixel  
*Mini HD compact cystoscope with 30° angled ocular, sheath 9-12 Fr., viewing angle 0°,  
working length 220mm, instrument channel 5 Fr., 3 luerlock connections, 40.000 pixel*

106

**AA-007-061**

Mini HD Kompakt-Cystoskop mit 30° abgewinkeltem Okular, Schaft 7.5-9 Charr., Blickwinkel 0°,  
Arbeitslänge 220mm, Instrumentenkanal 1 x 4 Charr. oder 2 x 2.4 Charr., 4 Luer-Lock Anschlüsse, 17.000 Pixel  
*Mini HD compact cystoscope with 30° angled ocular, sheath 7.5-9 Fr., viewing angle 0°,  
working length 220mm, instrument channel 1 x 4 Fr. or 2 x 2.4 Fr., 4 luerlock connections, 17.000 pixel*

107

**AA-007-062**

Mini HD Kompakt-Cystoskop mit 30° abgewinkeltem Okular, Schaft 6.5-8.1 Charr., Blickwinkel 0°,  
Arbeitslänge 220mm, Instrumentenkanal 1 x 3 Charr., 4 Luer-Lock Anschlüsse, 17.000 Pixel  
*Mini HD compact cystoscope with 30° angled ocular, sheath 6.5-8.1 Fr., viewing angle 0°,  
working length 220mm, instrument channel 1 x 3 Fr., 4 luerlock connections, 17.000 pixel*







	<b>Bestell-Nr. Ordering no.</b>	<b>Farbmarkierung Colour code</b>	
	<b>AH-001-202</b> 930	Gelb Yellow	Außenschäft <b>26</b> Charr. mit Lochperforation Outer sheath <b>26</b> Fr. with perforation
	<b>AH-001-212</b> 937	Schwarz Black	Außenschäft <b>28.5</b> Charr. mit Lochperforation Outer sheath <b>28.5</b> Fr. with perforation
	<b>AH-001-204</b> 932	Gelb Yellow	Außenschäft <b>26</b> Charr. mit oben/unten Perforation Outer sheath <b>26</b> Fr. with upper/lower perforation
	<b>AH-001-206</b> 934	Gelb Yellow	Außenschäft <b>26</b> Charr. mit oben Perforation Outer sheath <b>26</b> Fr. with upper perforation
	<b>AH-001-207</b> 935	Gelb Yellow	Außenschäft <b>26</b> Charr. mit unten Perforation Outer sheath <b>26</b> Fr. with lower perforation
	<b>AH-001-203</b> 931	Gelb Yellow	Außenschäft <b>26</b> Charr. mit rundum gefensterter Perforation Outer sheath <b>26</b> Fr. with surrounding fenestrated perforation
	<b>AH-001-205</b> 933	Gelb Yellow	Außenschäft <b>26</b> Charr. mit Perforation (oben gefenstert) Outer sheath <b>26</b> Fr. with perforation (upper fenestrated)
	<b>AH-001-216</b> 938	Schwarz Black	Außenschäft <b>28.5</b> Charr. mit Perforation (oben gefenstert) Outer sheath <b>28.5</b> Fr. with perforation (upper fenestrated)



	<b>Bestell-Nr. Ordering no.</b>	<b>Farbmarkierung Colour code</b>	
929	<b>AH-001-201</b>	Gelb Yellow	Innenschäft <b>26</b> Charr. mit Keramikisolation Inner sheath <b>26</b> Fr. with ceramic isolation
936	<b>AH-001-211</b>	Schwarz Black	Innenschäft <b>28.5</b> Charr. mit Keramikisolation Inner sheath <b>28.5</b> Fr. with ceramic isolation



	<b>Bestell-Nr. Ordering no.</b>	<b>Farbmarkierung Colour code</b>	
	<b>AH-001-302</b> 940	Gelb Yellow	Außenschaft <b>26</b> Charr. mit Lochperforation, drehbar <i>Outer sheath 26 Fr. with perforation, rotatable</i>
	<b>AH-001-312</b> 947	Schwarz Black	Außenschaft <b>28.5</b> Charr. mit Lochperforation, drehbar <i>Outer sheath 28.5 Fr. with perforation, rotatable</i>
	<b>AH-001-304</b> 942	Gelb Yellow	Außenschaft <b>26</b> Charr. mit oben/unten Perforation, drehbar <i>Outer sheath 26 Fr. with upper/lower perforation, rotatable</i>
	<b>AH-001-306</b> 944	Gelb Yellow	Außenschaft <b>26</b> Charr. mit oben Perforation, drehbar <i>Outer sheath 26 Fr. with upper perforation, rotatable</i>
	<b>AH-001-307</b> 945	Gelb Yellow	Außenschaft <b>26</b> Charr. mit unten Perforation, drehbar <i>Outer sheath 26 Fr. with lower perforation, rotatable</i>
	<b>AH-001-303</b> 941	Gelb Yellow	Außenschaft <b>26</b> Charr. mit rundum gefensterter Perforation, drehbar <i>Outer sheath 26 Fr. with surrounding fenestrated perforation, rotatable</i>
	<b>AH-001-305</b> 943	Gelb Yellow	Außenschaft <b>26</b> Charr. mit Perforation (oben gefenstert), drehbar <i>Outer sheath 26 Fr. with perforation (upper fenestrated), rotatable</i>
	<b>AH-001-316</b> 948	Schwarz Black	Außenschaft <b>28.5</b> Charr. mit Perforation (oben gefenstert), drehbar <i>Outer sheath 28.5 Fr. with perforation (upper fenestrated), rotatable</i>



	<b>Bestell-Nr. Ordering no.</b>	<b>Farbmarkierung Colour code</b>	
9	<b>AH-001-301</b>	Gelb Yellow	Innenschaft <b>26</b> Charr. mit Keramikisolation, drehbar <i>Inner sheath 26 Fr. with ceramic isolation, rotatable</i>
94	<b>AH-001-311</b>	Schwarz Black	Innenschaft <b>28.5</b> Charr. mit Keramikisolation, drehbar <i>Inner sheath 28.5 Fr. with ceramic isolation, rotatable</i>



	Bestell-Nr. Ordering no.	Farbmarkierung Colour code	
	<b>AH-001-001</b> 913	Gelb Yellow	Standard Resektoskopschaft <b>24</b> Charr. mit 1 <u>starr</u> en Hahn Standard resectoscope sheath <b>24</b> Fr. with 1 <u>fixed</u> stopcock
	<b>AH-001-002</b> 914	Schwarz Black	Standard Resektoskopschaft <b>27</b> Charr. mit 1 <u>starr</u> en Hahn Standard resectoscope sheath <b>27</b> Fr. with 1 <u>fixed</u> stopcock
	<b>AH-001-003</b> 915	Gelb Yellow	Standard Resektoskopschaft <b>24</b> Charr. mit distalem Fenster, 1 <u>starr</u> er Hahn Standard resectoscope sheath <b>24</b> Fr. with distal window, 1 <u>fixed</u> stopcock
	<b>AH-001-004</b> 916	Schwarz Black	Standard Resektoskopschaft <b>27</b> Charr. mit distalem Fenster, 1 <u>starr</u> er Hahn Standard resectoscope sheath <b>27</b> Fr. with distal window, 1 <u>fixed</u> stopcock



	Bestell-Nr. Ordering no.	Farbmarkierung Colour code	
	<b>AH-001-101</b> 925	Gelb Yellow	Standard Resektoskopschaft <b>24</b> Charr. mit <u>Zentralhahn</u> Standard resectoscope sheath <b>24</b> Fr. with <u>central valve</u>
	<b>AH-001-102</b> 926	Schwarz Black	Standard Resektoskopschaft <b>27</b> Charr. mit <u>Zentralhahn</u> Standard resectoscope sheath <b>27</b> Fr. with <u>central valve</u>
	<b>AH-001-103</b> 927	Gelb Yellow	Standard Resektoskopschaft <b>24</b> Charr. mit distalem Fenster, <u>Zentralhahn</u> Standard resectoscope sheath <b>24</b> Fr. with distal window, <u>central valve</u>
	<b>AH-001-104</b> 928	Schwarz Black	Standard Resektoskopschaft <b>27</b> Charr. mit distalem Fenster, <u>Zentralhahn</u> Standard resectoscope sheath <b>27</b> Fr. with distal window, <u>central valve</u>



7  
91

Bestell-Nr. Ordering no.	Farbmarkierung Colour code	Für Außenschaft For outer sheath	
AH-001-011	Gelb Yellow	26 Charr. 26 Fr.	Standardobturator für Resektoskopschäfte <b>24</b> Charr. Standardobturator for resectosope sheaths <b>24</b> Fr.
AH-001-012	Schwarz Black	28.5 Charr. 28.5 Fr.	Standardobturator für Resektoskopschäfte <b>27</b> Charr. Standardobturator for resectosope sheaths <b>27</b> Fr.



1  
92

Bestell-Nr. Ordering no.	Farbmarkierung Colour code	Für Außenschaft For outer sheath	
AH-001-015	Gelb Yellow	26 Charr. 26 Fr.	Beweglicher Obturator für Resektoskopschäfte <b>24</b> Charr. Deflecting obturator for resectosope sheaths <b>24</b> Fr.
AH-001-016	Schwarz Black	28.5 Charr. 28.5 Fr.	Beweglicher Obturator für Resektoskopschäfte <b>27</b> Charr. Deflecting obturator for resectosope sheaths <b>27</b> Fr.



9  
92

Bestell-Nr. Ordering no.	Farbmarkierung Colour code	Für Außenschaft For outer sheath	
AH-001-013	Gelb Yellow	26 Charr. 26 Fr.	Sichtobturator für Resektoskopschäfte <b>24</b> Charr. Viewing obturator for resectosope sheaths <b>24</b> Fr.
AH-001-014	Schwarz Black	28.5 Charr. 28.5 Fr.	Sichtobturator für Resektoskopschäfte <b>27</b> Charr. Viewing obturator for resectosope sheaths <b>27</b> Fr.



3  
92

Bestell-Nr. Ordering no.	Farbmarkierung Colour code	Für Außenschaft For outer sheath	
AH-001-017	Gelb Yellow	26 Charr. 26 Fr.	Sichtobturator für Resektoskopschäfte <b>24</b> Ch. mit 5 Ch. Instrumentenkanal Viewing obturator for resectosope sheaths <b>24</b> Fr. with 5 fr. instrument channel
AH-001-018	Schwarz Black	28.5 Charr. 28.5 Fr.	Sichtobturator für Resektoskopschäfte <b>27</b> Ch. mit 5 Ch. Instrumentenkanal Viewing obturator for resectosope sheaths <b>27</b> Fr. with 5 fr. instrument channel



**Bestell-Nr.**  
**Ordering no.**

888

**AG-001-001**

Arbeitselement für Resektoskope, **passiv** schneidend, Griff geschlossen, Schnitt durch Federdruck  
Working element used for resectoscopes, **passive** cutting, handle closed, cutting spring assisted



**Bestell-Nr.**  
**Ordering no.**

889

**AG-001-002**

Arbeitselement für Resektoskope, **passiv** schneidend, Griff offen, Schnitt durch Federdruck  
Working element used for resectoscopes, **passive** cutting, handle open, cutting spring assisted





**Bestell-Nr.**  
**Ordering no.**

890 **AG-001-003**

Arbeitselement für Resektoskope, **aktiv** schneidend, Griff geschlossen, Schnitt gegen Federdruck  
Working element used for resectoscopes, **active** cutting, handle closed, cutting against spring assistance

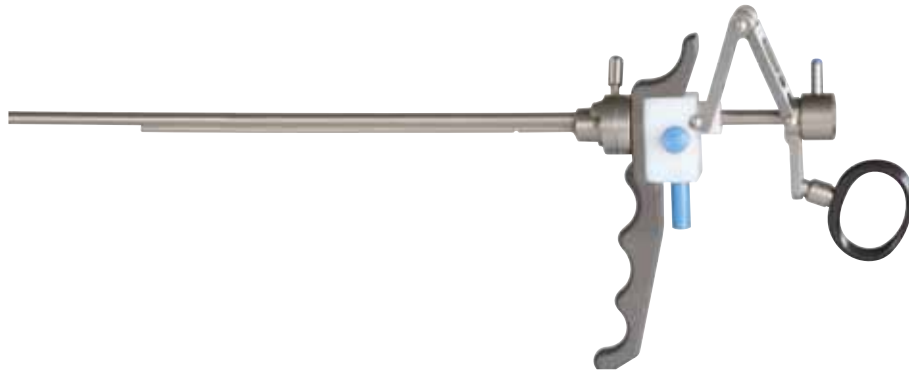

**Bestell-Nr.**  
**Ordering no.**

891 **AG-001-004**

Arbeitselement für Resektoskope, **aktiv** schneidend, Griff offen, Schnitt gegen Federdruck  
Working element used for resectoscopes, **active** cutting, handle open, cutting against spring assistance



**Bestell-Nr.**  
**Ordering no.**

894

**AG-001-007**

Arbeitselement für Resektoskope, titan, **passiv** schneidend, Griff geschlossen, Schnitt durch Federdruck  
Working element used for resectoscopes, titanium, **passive** cutting, handle closed, cutting spring assisted



**Bestell-Nr.**  
**Ordering no.**

895

**AG-001-008**

Arbeitselement für Resektoskope, titan, **aktiv** schneidend, Griff geschlossen, Schnitt gegen Federdruck  
Working element used for resectoscopes, titanium, **active** cutting, handle closed, cutting against spring assistance



**Bestell-Nr.**  
**Ordering no.**

3	<b>AG-001-006</b>	Arbeitselement für Laser-Resektoskope, <b>passiv</b> schneidend, Griff geschlossen, mit Kanal für Sonde 0.8mm <i>Working element used for resectoscopes, titanium, <b>passive</b> cutting, handle closed, with probe channel 0.8mm</i>
89	<b>AG-001-009</b>	Arbeitselement für Laser-Resektoskope, <b>passiv</b> schneidend, Griff geschlossen, mit Kanal für Sonde 1.2mm <i>Working element used for resectoscopes, titanium, <b>passive</b> cutting, handle closed, with probe channel 1.2mm</i>

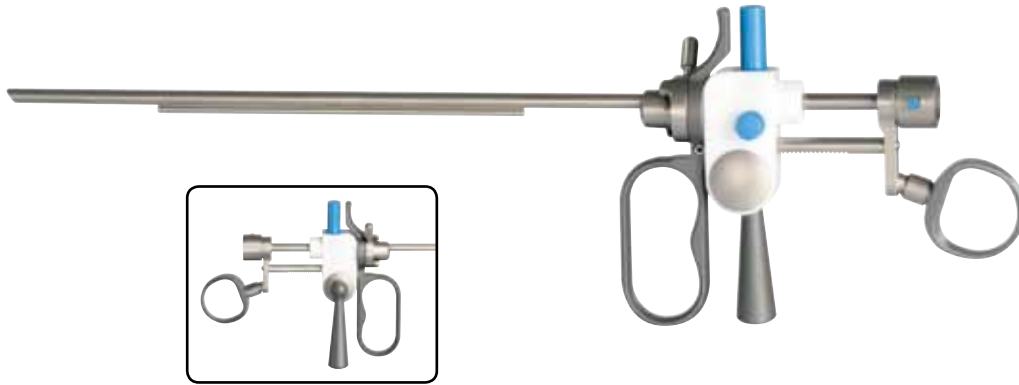













**Bestell-Nr.**  
**Ordering no.**

892

**AG-001-005**

Mc Carthy Arbeitselement für Resektoskope  
Mc Carthy Working element used for resectoscopes



	<b>Bestell-Nr.</b> <b>Ordering no.</b>	<b>Charr.</b> <b>Fr.</b>	
	<b>AE-001-001</b> 794	24 (gelb) 24 (yellow)	Schlingenelektrode 30° abgewinkelt <i>Cutting loop electrode 30° angled</i>
	<b>AE-002-001</b> 826	27 (braun) 27 (brown)	Schlingenelektrode 30° abgewinkelt <i>Cutting loop electrode 30° angled</i>
	<b>AE-001-002</b> 795	24 (gelb) 24 (yellow)	Schlingenelektrode abgewinkelt <i>Cutting loop electrode angled</i>
	<b>AE-002-002</b> 827	27 (braun) 27 (brown)	Schlingenelektrode abgewinkelt <i>Cutting loop electrode angled</i>
	<b>AE-001-003</b> 796	24 (gelb) 24 (yellow)	Schlingenelektrode gerade <i>Cutting loop electrode straight</i>
	<b>AE-002-003</b> 828	27 (braun) 27 (brown)	Schlingenelektrode gerade <i>Cutting loop electrode straight</i>
	<b>AE-001-004</b> 797	24 (gelb) 24 (yellow)	Kugelelektrode <b>Ø 3mm</b> <i>Rollerball electrode Ø 3mm</i>
	<b>AE-001-005</b> 798	24 (gelb) 24 (yellow)	Kugelelektrode <b>Ø 5mm</b> <i>Rollerball electrode Ø 5mm</i>
	<b>AE-001-009</b> 802	24 (gelb) 24 (yellow)	Kegelelektrode <i>Conical electrode</i>
	<b>AE-001-010</b> 803	24 (gelb) 24 (yellow)	Rollenelektrode <b>Ø 3mm</b> <i>Roller electrode Ø 3mm</i>
	<b>AE-001-011</b> 804	24 (gelb) 24 (yellow)	Rollenelektrode <b>Ø 5mm</b> <i>Roller electrode Ø 5mm</i>
	<b>AE-001-012</b> 805	24 (gelb) 24 (yellow)	Spikeelektrode <b>Ø 3mm</b> <i>Spike electrode Ø 3mm</i>
	<b>AE-001-013</b> 806	24 (gelb) 24 (yellow)	Spikeelektrode <b>Ø 5mm</b> <i>Spike electrode Ø 5mm</i>
	<b>AE-001-014</b> 807	24 (gelb) 24 (yellow)	Vaporisationselektrode <b>Ø 3mm</b> <i>Vaporization electrode Ø 3mm</i>
	<b>AE-001-015</b> 808	24 (gelb) 24 (yellow)	Vaporisationselektrode <b>Ø 5mm</b> <i>Vaporization electrode Ø 5mm</i>
	<b>AE-001-016</b> 809	24 (gelb) 24 (yellow)	Messerelektrode <i>Knife electrode</i>
	<b>AE-001-006</b> 799	24 (gelb) 24 (yellow)	Bandelektrode abgewinkelt <i>Band electrode angled</i>
	<b>AE-002-006</b> 829	27 (braun) 27 (brown)	Bandelektrode abgewinkelt <i>Band electrode angled</i>
	<b>AE-001-007</b> 800	24 (gelb) 24 (yellow)	Bandelektrode 30° abgewinkelt <i>Band electrode 30° angled</i>
	<b>AE-002-007</b> 830	27 (braun) 27 (brown)	Bandelektrode 30° abgewinkelt <i>Band electrode 30° angled</i>
	<b>AE-001-008</b> 801	24 (gelb) 24 (yellow)	Band Vaporisationselektrode abgewinkelt <i>Band vaporization electrode angled</i>
	<b>AE-001-017</b> 810	24 (gelb) 24 (yellow)	Kürette scharf, rund (nicht für den Gebrauch mit HF!) <i>Curette sharp, round, (not for use with HF!)</i>
	<b>AE-002-017</b> 831	27 (braun) 27 (brown)	Kürette scharf, rund (nicht für den Gebrauch mit HF!) <i>Curette sharp, round, (not for use with HF!)</i>



**Bestell-Nr.**  
**Ordering no.**

**AJ-010-006**

Schutzhülse aus Stahl zur Sterilisation und Aufbewahrung von Elektroden und Strikturmessern  
Protection sleeve made of steel for sterilization and storage of electrodes and cold knives

1154

Anschluss Instrumentenseite Connection instrument side	Anschluss Geräteseite Connection unit side
	<b>AD-010-001 / AD-010-006</b>
	<b>AD-010-002 / AD-010-007</b>
	<b>AD-010-003 / AD-010-008</b>
	<b>AD-010-004 / AD-010-005</b>
	<b>AD-010-021</b>
	<b>AD-010-024</b>
<p>Alle Kabel passen zu den Arbeitselementen AG-001-001 bis AG-001-009 All cables fit with the working elements AG-001-001 to AG-001-009</p>	

Bestell-Nr. Ordering no.	Länge Length	
<b>AD-010-001</b>	3m	Monopolares Anschlusskabel für <b>Bertchold, Martin, Aesculap</b> , Ø 4mm
<b>AD-010-006</b>	5m	Monopolar connecting cable for <b>Bertchold, Martin, Aesculap</b> , Ø 4mm
<b>AD-010-002</b>	3m	Monopolares Anschlusskabel für <b>Erbe, ACC/ICC, Storz</b> , Ø 5mm
<b>AD-010-007</b>	5m	Monopolar connecting cable for <b>Erbe, ACC/ICC, Storz</b> , Ø 5mm
<b>AD-010-003</b>	3m	Monopolares Anschlusskabel für <b>Valleylab/Conmed</b> , Ø 8mm
<b>AD-010-008</b>	5m	Monopolar connecting cable for <b>Valleylab/Conmed</b> , Ø 8mm
<b>AD-010-004</b>	3m	Monopolares Anschlusskabel für Geräte mit <b>4mm Bananenstecker</b>
<b>AD-010-005</b>	5m	Monopolar connecting cable for units with <b>4mm banana plug</b>
<b>AD-010-021</b>	4.5m	Monopolares Anschlusskabel für <b>STEMA MASTER</b> Geräte mit <b>SDS-Erkennung</b> Monopolar connecting cable for <b>STEMA MASTER</b> units with <b>SDS identification</b>
<b>AD-010-024</b>	4.5m	Monopolares Anschlusskabel für <b>STEMA MASTER</b> Geräte Monopolar connecting cable for <b>STEMA MASTER</b> units

0  
78  
6  
78  
9  
78



**Bestell-Nr.**  
**Ordering no.**

<b>AA-001-003</b>	Resektoskop Ø 2.7mm, Blickwinkel 30°, autoklavierbar Resectoscope Ø 2.7mm, 30° viewing angle, autoclavable
<b>AA-003-002</b>	Resektoskop Ø 2.9mm, Blickwinkel 30°, autoklavierbar Resectoscope Ø 2.9mm, 30° viewing angle, autoclavable
<b>AA-001-013</b>	<b>HD</b> Resektoskop Ø 2.7mm, Blickwinkel 30°, autoklavierbar <b>HD</b> Resectoscope Ø 2.7mm, 30° viewing angle, autoclavable
<b>AA-003-012</b>	<b>HD</b> Resektoskop Ø 2.9mm, Blickwinkel 30°, autoklavierbar <b>HD</b> Resectoscope Ø 2.9mm, 30° viewing angle, autoclavable



**Bestell-Nr.**  
**Ordering no.**      **Farbmarkierung**  
**Colour code**

	<b>AH-002-212</b> 955	Weiß White	Außenschäft <b>22</b> Charr. mit Lochperforation Outer sheath <b>22</b> Fr. with perforation
---	-----------------------	---------------	---



**Bestell-Nr.**  
**Ordering no.**      **Farbmarkierung**  
**Colour code**

953

<b>AH-002-201</b>	Weiß White	Innenschäft <b>19</b> Charr. mit Keramikisolation Inner sheath <b>19</b> Fr. with ceramic isolation
-------------------	---------------	--



**Bestell-Nr.**  
**Ordering no.**      **Farbmarkierung**  
**Colour code**      **Für Außenschäft**  
**For outer sheath**

950

<b>AH-002-011</b>	Weiß White	22 Charr. 22 Fr.	Standardobturator <b>19</b> Charr. Standardobturator <b>19</b> Fr.
-------------------	---------------	---------------------	---



**Bestell-Nr.**  
**Ordering no.**      **Farbmarkierung**  
**Colour code**      **Für Außenschäft**  
**For outer sheath**

951

<b>AH-002-013</b>	Weiß White	22 Charr. 22 Fr.	Sichtobturator <b>19</b> Charr. Viewing obturator <b>19</b> Fr.
-------------------	---------------	---------------------	--



**Bestell-Nr.**  
**Ordering no.**

<b>AA-001-003</b>	Resektoskop Ø 2.7mm, Blickwinkel 30°, autoklavierbar Resectoscope Ø 2.7mm, 30° viewing angle, autoclavable
<b>AA-003-002</b>	Resektoskop Ø 2.9mm, Blickwinkel 30°, autoklavierbar Resectoscope Ø 2.9mm, 30° viewing angle, autoclavable
<b>AA-001-013</b>	<b>HD</b> Resektoskop Ø 2.7mm, Blickwinkel 30°, autoklavierbar <b>HD</b> Resectoscope Ø 2.7mm, 30° viewing angle, autoclavable
<b>AA-003-012</b>	<b>HD</b> Resektoskop Ø 2.9mm, Blickwinkel 30°, autoklavierbar <b>HD</b> Resectoscope Ø 2.9mm, 30° viewing angle, autoclavable



**Bestell-Nr.**  
**Ordering no.**      **Farbmarkierung**  
**Colour code**



<b>AH-002-302 948</b>	Weiß White	Außenschäft <b>22</b> Charr. mit Lochperforation, drehbar Outer sheath <b>22</b> Fr. with perforation, rotatable
-----------------------	---------------	---



**Bestell-Nr.**  
**Ordering no.**      **Farbmarkierung**  
**Colour code**

<b>AH-002-301</b>	Weiß White	Innenschäft <b>22</b> Charr. mit Keramikisolation, drehbar Inner sheath <b>22</b> Fr. with ceramic isolation, rotatable
-------------------	---------------	--

947



**Bestell-Nr.**  
**Ordering no.**      **Farbmarkierung**  
**Colour code**      **Für Außenschäft**  
**For outer sheath**

<b>AH-002-011</b>	Weiß White	22 Charr. 22 Fr.	Standardobturator <b>19</b> Charr. Standardobturator <b>19</b> Fr.
-------------------	---------------	---------------------	---



**Bestell-Nr.**  
**Ordering no.**      **Farbmarkierung**  
**Colour code**      **Für Außenschäft**  
**For outer sheath**

<b>AH-002-013</b>	Weiß White	22 Charr. 22 Fr.	Sichtobturator <b>19</b> Charr. Viewing obturator <b>19</b> Fr.
-------------------	---------------	---------------------	--





**Bestell-Nr.**  
**Ordering no.**

<b>AA-001-003</b>	Resektoskop Ø 2.7mm, Blickwinkel 30°, autoklavierbar Resectoscope Ø 2.7mm, 30° viewing angle, autoclavable
<b>AA-003-002</b>	Resektoskop Ø 2.9mm, Blickwinkel 30°, autoklavierbar Resectoscope Ø 2.9mm, 30° viewing angle, autoclavable
<b>AA-001-013</b>	<b>HD</b> Resektoskop Ø 2.7mm, Blickwinkel 30°, autoklavierbar <b>HD</b> Resectoscope Ø 2.7mm, 30° viewing angle, autoclavable
<b>AA-003-012</b>	<b>HD</b> Resektoskop Ø 2.9mm, Blickwinkel 30°, autoklavierbar <b>HD</b> Resectoscope Ø 2.9mm, 30° viewing angle, autoclavable



**Bestell-Nr.**  
**Ordering no.**      **Farbmarkierung**  
**Colour code**



<b>AH-002-001</b> 749	Weiß White	Standard Resektoskopschaft 19 Ch., 1 starren Hahn, ohne Obturator Standard resectoscope sheath 19 Fr., 1 fixed stopcock, without obturator
-----------------------	---------------	---



**Bestell-Nr.**  
**Ordering no.**      **Farbmarkierung**  
**Colour code**      **Für Außenschaft**  
**For outer sheath**

<b>AH-002-011</b>	Weiß White	22 Charr. 22 Fr.	Standardobturator <b>19</b> Charr. Standardobturator <b>19</b> Fr.
-------------------	---------------	---------------------	---



**Bestell-Nr.**  
**Ordering no.**      **Farbmarkierung**  
**Colour code**      **Für Außenschaft**  
**For outer sheath**

<b>AH-002-013</b>	Weiß White	22 Charr. 22 Fr.	Sichtobturator <b>19</b> Charr. Viewing obturator <b>19</b> Fr.
-------------------	---------------	---------------------	--



**Bestell-Nr.**  
**Ordering no.**

900

**AG-002-001**

Arbeitselement für SLIM Resektoskope, **passiv** schneidend, Griff geschlossen, Schnitt durch Federdruck  
Working element used for SLIM resectoscopes, **passive** cutting, handle closed, cutting spring assisted



**Bestell-Nr.**  
**Ordering no.**

901

**AG-002-002**

Arbeitselement für Resektoskope, **passiv** schneidend, Griff offen, Schnitt durch Federdruck  
Working element used for resectoscopes, **passive** cutting, handle open, cutting spring assisted



**Bestell-Nr.**  
**Ordering no.**

902

**AG-002-003**

Arbeits element für Resektoskope, **aktiv** schneidend, Griff geschlossen, Schnitt gegen Federdruck  
Working element used for resectoscopes, **active** cutting, handle closed, cutting against spring assistance

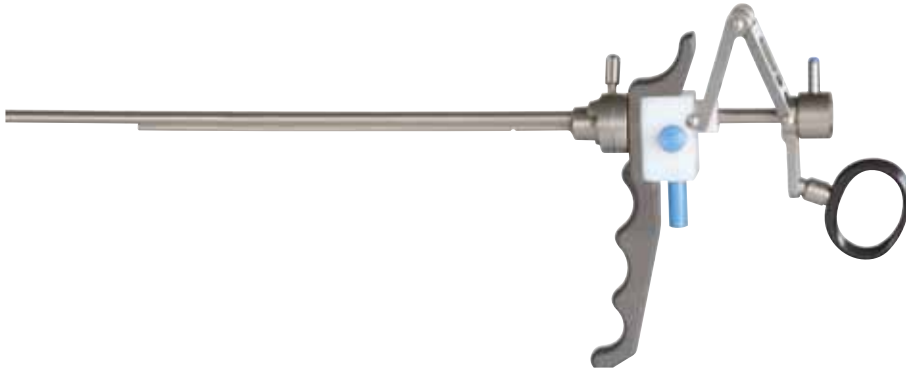



**Bestell-Nr.**  
**Ordering no.**

903

**AG-002-004**

Arbeits element für Resektoskope, **aktiv** schneidend, Griff offen, Schnitt gegen Federdruck  
Working element used for resectoscopes, **active** cutting, handle open, cutting against spring assistance



	<b>Bestell-Nr.</b> <b>Ordering no.</b>	<b>Charr.</b> <b>Fr.</b>	
	<b>AE-003-001</b> 832	19 (weiß) 19 (white)	Schlingenelektrode 30° abgewinkelt Cutting loop electrode 30° angled
	<b>AE-003-003</b> 833	19 (weiß) 19 (white)	Schlingenelektrode gerade Cutting loop electrode straight
	<b>AE-003-004</b> 834	19 (weiß) 19 (white)	Kugelelektrode Ø 3mm Rollerball electrode Ø 3mm
	<b>AE-003-010</b> 835	19 (weiß) 19 (white)	Rollenelektrode Ø 3mm Roller electrode Ø 3mm
	<b>AE-003-014</b> 836	19 (weiß) 19 (white)	Vaporisationselektrode Vaporization electrode
	<b>AE-003-016</b> 837	19 (weiß) 19 (white)	Messerelektrode Knife electrode



Bestell-Nr.  
Ordering no.

1164

**AJ-010-006**

Schutzhülse aus Stahl zur Sterilisation und Aufbewahrung von Elektroden und Strikturmessern  
Protection sleeve made of steel for sterilization and storage of electrodes and cold knives

Anschluss Instrumentenseite Connection instrument side	Anschluss Geräteseite Connection unit side
	<b>AD-010-001 / AD-010-006</b>
	<b>AD-010-002 / AD-010-007</b>
	<b>AD-010-003 / AD-010-008</b>
	<b>AD-010-004 / AD-010-005</b>
	<b>AD-010-021</b>
	<b>AD-010-024</b>

Alle Kabel passen zu den Arbeitselementen AG-002-001 bis AG-002-004  
All cables fit with the working elements AG-002-001 to AG-002-004

Bestell-Nr. Ordering no.	Länge Length	
<b>AD-010-001</b>	3m	Monopolares Anschlusskabel für <b>Bertchold, Martin, Aesculap</b> , Ø 4mm
<b>AD-010-006</b>	5m	Monopolar connecting cable for <b>Bertchold, Martin, Aesculap</b> , Ø 4mm
<b>AD-010-002</b>	3m	Monopolares Anschlusskabel für <b>Erbe, ACC/ICC, Storz</b> , Ø 5mm
<b>AD-010-007</b>	5m	Monopolar connecting cable for <b>Erbe, ACC/ICC, Storz</b> , Ø 5mm
<b>AD-010-003</b>	3m	Monopolares Anschlusskabel für <b>Valleylab/Conmed</b> , Ø 8mm
<b>AD-010-008</b>	5m	Monopolar connecting cable for <b>Valleylab/Conmed</b> , Ø 8mm
<b>AD-010-004</b>	3m	Monopolares Anschlusskabel für Geräte mit <b>4mm Bananenstecker</b>
<b>AD-010-005</b>	5m	Monopolar connecting cable for units with <b>4mm banana plug</b>
<b>AD-010-021</b>	4.5m	Monopolares Anschlusskabel für <b>STEMA MASTER</b> Geräte mit <b>SDS-Erkennung</b>
		Monopolar connecting cable for <b>STEMA MASTER</b> units with <b>SDS identification</b>
<b>AD-010-024</b>	4.5m	Monopolares Anschlusskabel für <b>STEMA MASTER</b> Geräte
		Monopolar connecting cable for <b>STEMA MASTER</b> units



**Bestell-Nr.**  
**Ordering no.**

<b>AA-003-002</b>	Resektoskop Ø 2.9mm, Blickwinkel 30°, autoklavierbar <i>Resectoscope Ø 2.9mm, 30° viewing angle, autoclavable</i>
<b>AA-003-012</b>	<b>HD</b> Resektoskop Ø 2.9mm, Blickwinkel 30°, autoklavierbar <b>HD</b> Resectoscope Ø 2.9mm, 30° viewing angle, autoclavable



**Bestell-Nr.**  
**Ordering no.**      **Farbmarkierung**  
**Colour code**



<b>AH-002-213</b>	Grün <i>Green</i>	Außenschaft <b>18.5</b> Charr. mit Lochperforation <i>Outer sheath 18.5 Fr. with perforation</i>
-------------------	----------------------	---



**Bestell-Nr.**  
**Ordering no.**      **Farbmarkierung**  
**Colour code**

954

<b>AH-002-211</b>	Grün <i>Green</i>	Innenschaft <b>17.5</b> Charr. mit Keramikisolation, drehbar <i>Inner sheath 17.5 Fr. with ceramic isolation, rotatable</i>
-------------------	----------------------	--



**Bestell-Nr.**  
**Ordering no.**      **Farbmarkierung**  
**Colour code**      **Für Außenschaft**  
**For outer sheath**

952

<b>AH-002-015</b>	Grün <i>Green</i>	18.5 Charr. <i>18.5 Fr.</i>	Standardobturator <b>17.5</b> Charr. <i>Standardobturator 17.5 Fr.</i>
-------------------	----------------------	--------------------------------	---



**Bestell-Nr.**  
**Ordering no.**

904	<b>AG-002-010</b>	Arbeitselement für MINI Resektoskope, <b>passiv</b> schneidend, Griff geschlossen, Schnitt durch Federdruck Working element used for MINI resectoscopes, <b>passive</b> cutting, handle closed, cutting spring assisted
908	<b>AG-002-014</b>	Arbeitselement für MINI Resektoskope, <b>aktiv</b> schneidend, Griff geschlossen, Schnitt durch Federdruck Working element used for MINI resectoscopes, <b>active</b> cutting, handle closed, cutting spring assisted



	<b>Bestell-Nr.</b> <b>Ordering no.</b>	<b>Charr.</b> <b>Fr.</b>	
	<b>AE-003-021 838</b>	17.5 (grün) 17.5 (green)	Schlingenelektrode 30° abgewinkelt Cutting loop electrode 30° angled
	<b>AE-003-023 839</b>	17.5 (grün) 17.5 (green)	Schlingenelektrode gerade Cutting loop electrode straight
	<b>AE-003-024 840</b>	17.5 (grün) 17.5 (green)	Kugelelektrode Ø 2mm Rollerball electrode Ø 2mm
	<b>AE-003-025 841</b>	17.5 (grün) 17.5 (green)	Rollenelektrode Ø 2mm Rollerball electrode Ø 2mm
	<b>AE-003-026 842</b>	17.5 (grün) 17.5 (green)	Messerelektrode Knife electrode



**Bestell-Nr.**  
**Ordering no.**

9	<b>AG-002-015</b>	SALINE Arbeitselement für MINI Resektoskope, <b>passiv</b> schneidend, Griff geschlossen, Schnitt durch Federdruck SALINE Working element used for MINI resectoscopes, <b>passive</b> cutting, handle closed, cutting spring assisted
90	<b>AG-002-013</b>	SALINE Arbeitselement für MINI Resektoskope, <b>aktiv</b> schneidend, Griff geschlossen, Schnitt durch Federdruck SALINE Working element used for MINI resectoscopes, <b>active</b> cutting, handle closed, cutting spring assisted



	<b>Bestell-Nr.</b> <b>Ordering no.</b>	<b>Charr.</b> <b>Fr.</b>	
	<b>AE-003-041</b> 849	17.5 (grün) 17.5 (green)	Schlingenelektrode 30° abgewinkelt Cutting loop electrode 30° angled
	<b>AE-003-043</b> 850	17.5 (grün) 17.5 (green)	Schlingenelektrode gerade Cutting loop electrode straight
	<b>AE-003-044</b> 851	17.5 (grün) 17.5 (green)	Kugelelektrode Ø 2mm Rollerball electrode Ø 2mm
	<b>AE-003-045</b> 852	17.5 (grün) 17.5 (green)	Rollenelektrode Ø 2mm Rollerball electrode Ø 2mm
	<b>AE-003-046</b> 853	17.5 (grün) 17.5 (green)	Messerelektrode Knife electrode







**Bestell-Nr.**  
**Ordering no.**

5	<b>AG-002-011</b>	SALINE Arbeitselement für MINI Resektoskope, <b>passiv</b> schneidend, Griff geschlossen, Schnitt durch Federdruck SALINE Working element used for MINI resectoscopes, <b>passive</b> cutting, handle closed, cutting spring assisted
90	<b>AG-002-012</b>	SALINE Arbeitselement für MINI Resektoskope, <b>aktiv</b> schneidend, Griff geschlossen, Schnitt durch Federdruck SALINE Working element used for MINI resectoscopes, <b>active</b> cutting, handle closed, cutting spring assisted



	<b>Bestell-Nr.</b> <b>Ordering no.</b>	<b>Charr.</b> <b>Fr.</b>	
	<b>AE-003-031</b> 843	19 (weiß-blau) 19 (white-blue)	Schlingenelektrode 30° abgewinkelt Cutting loop electrode 30° angled
	<b>AE-003-032</b> 844	19 (weiß-blau) 19 (white-blue)	Schlingenelektrode 90° abgewinkelt Cutting loop electrode 90° angled
	<b>AE-003-033</b> 845	19 (weiß-blau) 19 (white-blue)	Schlingenelektrode gerade Cutting loop electrode straight
	<b>AE-003-034</b> 846	19 (weiß-blau) 19 (white-blue)	Kugelelektrode Ø 3mm Rollerball electrode Ø 3mm
	<b>AE-003-040</b> 848	19 (weiß-blau) 19 (white-blue)	Rollenelektrode Ø 3mm Roller electrode Ø 3mm
	<b>AE-003-036</b> 847	19 (weiß-blau) 19 (white-blue)	Messerelektrode Knife electrode



**Bestell-Nr.**  
**Ordering no.**

989

**AG-001-011**

SALINE Arbeitselement für Resektoskope, **passiv** schneidend, Griff geschlossen, Schnitt durch Federdruck  
SALINE working element used for resectoscopes, **passive** cutting, handle closed, cutting spring assistance















**Bestell-Nr.**  
**Ordering no.**

899

**AG-001-012**

SALINE Arbeitselement für Resektoskope, **aktiv** schneidend, Griff geschlossen, Schnitt gegen Federdruck  
SALINE working element used for resectoscopes, **active** cutting, handle closed, cutting against spring assistance









	<b>Bestell-Nr. Ordering no.</b>	<b>Charr. Fr.</b>	
	<b>AE-001-030 811</b>	24 (blau/gelb) 24 (blue/yellow)	Schlingenelektrode 30° abgewinkelt, starker Schnitt Cutting loop electrode 30° angled, strong cut
	<b>AE-001-031 812</b>	24 (blau/gelb) 24 (blue/yellow)	Schlingenelektrode 30° abgewinkelt Cutting loop electrode 30° angled
	<b>AE-001-032 813</b>	24 (blau/gelb) 24 (blue/yellow)	Messerelektrode Knife electrode
	<b>AE-001-033 814</b>	24 (blau/gelb) 24 (blue/yellow)	Schlingenelektrode 90° abgewinkelt Cutting loop electrode 90° angled
	<b>AE-001-034 815</b>	24 (blau/gelb) 24 (blue/yellow)	Kugelelektrode Ø 3mm Rollerball electrode Ø 3mm
	<b>AE-001-035 816</b>	24 (blau/gelb) 24 (blue/yellow)	Kugelelektrode Ø 5mm Rollerball electrode Ø 5mm
	<b>AE-001-036 817</b>	24 (blau/gelb) 24 (blue/yellow)	Schlingenelektrode gerade Cutting loop electrode straight
	<b>AE-001-037 818</b>	24 (blau/gelb) 24 (blue/yellow)	Vaporisations Rollenelektrode glatt Ø 3mm Vaprisation rollerball electrode smooth Ø 3mm
	<b>AE-001-043 824</b>	24 (blau/gelb) 24 (blue/yellow)	Vaporisations Rollenelektrode glatt Ø 5mm Vaprisation rollerball electrode smooth Ø 5mm
	<b>AE-001-038 819</b>	24 (blau/gelb) 24 (blue/yellow)	Vaporisations Spikerollenelektrode Ø 3mm Vaprisation spike rollerball electrode Ø 3mm
	<b>AE-001-039 820</b>	24 (blau/gelb) 24 (blue/yellow)	Kegelelektrode Conical electrode
	<b>AE-001-040 821</b>	24 (blau/gelb) 24 (blue/yellow)	Rollenelektrode Ø 3mm Rollerball electrode smooth Ø 3mm
	<b>AE-001-042 238</b>	24 (blau/gelb) 24 (blue/yellow)	Rollenelektrode glatt Ø 5mm Rollerball electrode smooth Ø 5mm
	<b>AE-001-041 822</b>	24 (blau/gelb) 24 (blue/yellow)	Bandelektrode 30° abgewinkelt Band electrode 30° angled
	<b>AE-001-044 825</b>	24 (blau/gelb) 24 (blue/yellow)	Kegelelektrode „Mushroom“ Conical electrode „Mushroom“



**Bestell-Nr.**  
**Ordering no.**

**AJ-010-006**

Schutzhülse aus Stahl zur Sterilisation und Aufbewahrung von Elektroden und Strikturmessern  
*Protection sleeve made of steel for sterilization and storage of electrodes and cold knives*

Anschluss Instrumentenseite <i>Connection instrument side</i>	Anschluss Geräteseite <i>Connection unit side</i>
	<p><b>AD-010-011</b> </p>
	<p><b>AD-010-012</b> </p>
	<p><b>AD-010-013</b> </p>
	<p><b>AD-010-014</b> </p>
	<p><b>AD-010-031</b> </p>
	<p><b>AD-010-034</b> </p>
<p>Alle Kabel passen zu den Arbeitselementen AG-001-011 und AG-001-012 <i>All cables fit with the working elements AG-001-011 and AG-001-012</i></p>	

Bestell-Nr. Ordering no.	Länge Length	
<b>AD-010-011</b>	4.5m	Bipolares Resektoskop-Anschlusskabel für <b>Martin Maxium</b> <i>Bipolar resectoscope connecting cable for <b>Martin Maxium</b></i>
<b>AD-010-012</b>	4.5m	Bipolares Resektoskop-Anschlusskabel für <b>Erbe Vio</b> <i>Bipolar resectoscope connecting cable for <b>Erbe Vio</b></i>
<b>AD-010-013</b>	4.5m	Bipolares Resektoskop-Anschlusskabel für <b>Valleylab, Lamidey, EMC</b> <i>Bipolar resectoscope connecting cable for <b>Valleylab, Lamidey, EMC</b></i>
<b>AD-010-014</b>	4.5m	Bipolares Resektoskop-Anschlusskabel mit <b>2 Bananensteckern</b> geräteseitig <i>Bipolar resectoscope connecting cable for <b>2 banana plugs</b> unit side</i>
<b>AD-010-031</b>	4.5m	Bipolares Resektoskop-Anschlusskabel für <b>STEMA MASTER</b> Geräte mit <b>SDS-Erkennung</b> <i>Bipolar resectoscope connecting cable for <b>STEMA MASTER</b> units with <b>SDS identification</b></i>
<b>AD-010-034</b>	4.5m	Bipolares Resektoskop-Anschlusskabel mit <b>STEMA MASTER</b> Geräte <i>Bipolar resectoscope connecting cable for <b>STEMA MASTER</b> units</i>

79  
2

**ACHTUNG: Diese Artikel sind nur auf Anfrage erhältlich!**  
**ATTENTION: These items are only available on request!**



**Bestell-Nr.**  
**Ordering no.**

**AB-007-001** Suprapubisches Aspirationsbesteck, komplettes Set  
Suprapubic aspiration set, complete set



**Bestell-Nr.**  
**Ordering no.**

**AB-007-002** Trokarhülse 16 Ch. mit Druckmesskanal  
Trocar sleeve 16 Fr. with pressure measuring channel

229



**Bestell-Nr.**  
**Ordering no.**

**AB-007-003** Stabilisierungsscheibe, seitlich geöffnet  
Adjustable stabilisation disc, lateral opening



**Bestell-Nr.**  
**Ordering no.**

**AB-007-008** Führungshülse, seitlich geöffnet, zum Einlegen eines suprapubischen Ballonkatheters  
Guide sleeve, lateral opening, for inserting a suprapubic catheter

**ACHTUNG: Diese Artikel sind nur auf Anfrage erhältlich!**  
**ATTENTION: These items are only available on request!**



**Bestell-Nr.**  
**Ordering no.**

230

**AB-007-004**

Trocar mit Kanülenspitze  
*Trocar with cannula tip*



**Bestell-Nr.**  
**Ordering no.**

231

**AB-007-005**

Trocar mit Dreikantspitze  
*Trocar with pyramidal tip*



**Bestell-Nr.**  
**Ordering no.**

232

**AB-007-006**

Aspirationskanüle  
*Aspiration cannula*



**Bestell-Nr.**  
**Ordering no.**

233

**AB-007-007**

Überlaufkanüle zur Druckstabilisierung  
*Overflow cannula for pressure stabilisation*

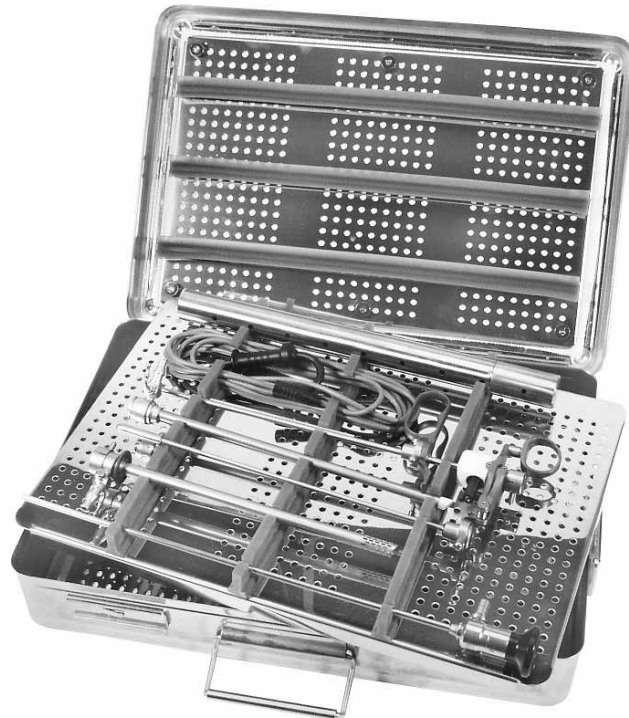

**AJ-010-020 /  
AJ-010-021 /  
FA-600-001**

**Bestell-Nr.  
Ordering no.**

1166	<b>AJ-010-020</b>	Behältereinatz für Resektoskopie (ohne Instrumente, ohne Sterilisationskassette), Abmessung 370 x 255 x 45mm (L x B x H) Vorbereitet für folgende Artikel: AA-002-003, AG-001-001, AH-001-011, AH-001-302, AH-001-302, AJ-010-006, AJ-020-001 Tray insert for resectoscopy (without instruments, without sterilization box), dimension 370 x 255 x 45mm (l x w x h) Prepared for the following items: AA-002-003, AG-001-001, AH-001-011, AH-001-302, AH-001-302, AJ-010-006, AJ-020-001
1167	<b>AJ-010-021</b>	Behältereinatz für Cystoskopie (ohne Instrumente, ohne Sterilisationskassette), Abmessung 370 x 255 x 45mm (L x B x H) Vorbereitet für folgende Artikel: AA-002-003, AB-001-002, AB-001-003, AB-001-004, AB-003-002, AB-003-003, AB-003-004, AB-003-007 Tray insert for cystoscopy (without instruments, without sterilization box), dimension 370 x 255 x 45mm (l x w x h) Prepared for the following items: AA-002-003, AB-001-002, AB-001-003, AB-001-004, AB-003-002, AB-003-003, AB-003-004, AB-003-007
4401	<b>FA-600-001</b>	Sterilisierkassette für STEMA Urologietrays AJ-010-020 und AJ-010-021, 400 x 290 x 75mm Sterilization case for STEMA urology trays AJ-010-020 and AJ-010-021, 400 x 290 x 75mm



	<b>Bestell-Nr.</b> <b>Ordering no.</b>	
100	<b>AJ-002-001</b>	Ellik Evakuator komplett mit Schaftanschluss und Verriegelung <i>Ellik evacuator complete with sheath connection and locking device</i>
3	<b>AJ-002-002</b>	Glasbehälter allein <i>Bowl only</i>
100	<b>AJ-002-003</b>	Gummiball allein <i>Suction ball only</i>
4	<b>AJ-002-004</b>	Konus mit Schlauch allein <i>Cone with tube only</i>
100	<b>AJ-002-005</b>	Schaftanschluss für Ellik allein <i>Sheath connection for Ellik only</i>
5		

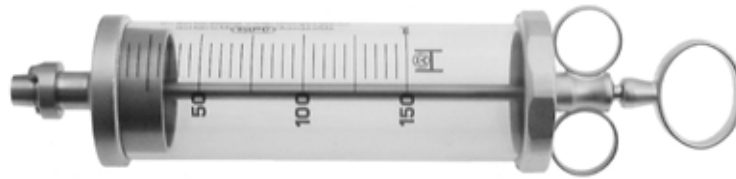

	<b>Bestell-Nr.</b> <b>Ordering no.</b>	
995	<b>AJ-001-000</b>	RECORD Blasenspritze mit Adapter, 50ml <i>RECORD syringe with adapter, 50ml</i>
	<b>AJ-001-010</b>	Ersatzzylinder für RECORD Blasenspritze mit Adapter, 50ml <i>Replacement cylinder for RECORD syringe with adapter, 50ml</i>
999	<b>AJ-001-001</b>	RECORD Blasenspritze mit Adapter, 75ml <i>RECORD syringe with adapter, 75ml</i>
997	<b>AJ-001-011</b>	Ersatzzylinder für RECORD Blasenspritze mit Adapter, 75ml <i>Replacement cylinder for RECORD syringe with adapter, 75ml</i>
	<b>AJ-001-002</b>	RECORD Blasenspritze mit Adapter, 100ml <i>RECORD syringe with adapter, 100ml</i>
100	<b>AJ-001-012</b>	Ersatzzylinder für RECORD Blasenspritze mit Adapter, 100ml <i>Replacement cylinder for RECORD syringe with adapter, 100ml</i>
0		
	<b>AJ-001-003</b>	RECORD Blasenspritze mit Adapter, 150ml <i>RECORD syringe with adapter, 150ml</i>
998	<b>AJ-001-013</b>	Ersatzzylinder für RECORD Blasenspritze mit Adapter, 150ml <i>Replacement cylinder for RECORD syringe with adapter, 150ml</i>





Bestell-Nr. Ordering no.	Arbeitslänge Working length	
41 AA-006-012	250mm	Nephroskop mit 90° abgewinkeltem Okular, Ø 7.45mm, Blickwinkel 0°, Spülkanal Ø 1.5mm, Arbeitskanal Ø 4.7mm Nephroscope with 90° angled ocular, Ø 7.45mm, viewing angle 0°, suction channel Ø 1.5mm, working channel Ø 4.7mm



175

Bestell-Nr.  
Ordering no.

AB-004-010-QL

Adapter für den Einsatz mit Nephroskop und Resektoskopschäften 26 Charr. STEMA Click-System  
Adaptor for use with nephroscope and resectoscope sheaths 26 Fr. STEMA Click-System



Bestell-Nr. Ordering no.	Farbmarkierung Colour code	
AH-001-301	Gelb Yellow	Innenschaft 26 Charr. mit Keramikisolation, drehbar Inner sheath 26 Fr. with ceramic isolation, rotatable



Bestell-Nr.  
Ordering no.

AH-001-302

Farbmarkierung  
Colour code

Gelb  
Yellow

Außenschaft 26 Charr. mit Lochperforation, drehbar  
Outer sheath 26 Fr. with perforation, rotatable



Bestell-Nr. Ordering no.	Farbmarkierung Colour code	Für Außenschaft For outer sheath	
AH-001-011	Gelb Yellow	26 Charr. 26 Fr.	Standardobturator für Resektoskopschäfte 24 Charr. Standardobturator for resectoscope sheaths 24 Fr.



**Bestell-Nr.**  
**Ordering no.**



**AI-002-001 974**

OTIS Urethrotom mit 3 austauschbaren Spitzen inklusive 2 Messern  
OTIS urethrotome with 3 exchangeable tips inclusive 2 knives



**Bestell-Nr.**  
**Ordering no.**

975

**AI-002-002**

Ersatzmesser für OTIS Urethrotom  
Spare knives for OTIS urethrotome



Das OTIS Urethrotom ist auf Anfrage auch für Kinder erhältlich.  
The OTIS urethrotome is on request also available for children.





**Bestell-Nr.**  
**Ordering no.**

**AA-002-001** Zystoskop Ø 4.0mm, Blickwinkel 0°, autoklavierbar  
*Cystoscope Ø 4.0mm, 0° viewing angle, autoclavable*

**AA-002-011** **HD** Zystoskop Ø 4.0mm, Blickwinkel 0°, autoklavierbar  
**HD** *Cystoscope Ø 4.0mm, 0° viewing angle, autoclavable*



**AI-001-001**

**AI-001-003**

**Bestell-Nr.**  
**Ordering no.**

**3** **AI-001-001** Urethrotomschaft 21 Charr. mit Instrumentenkanal 5 Charr.  
*Urethrotome sheath 21 Fr. with instrument channel 5 Fr.*

**96** **AI-001-003** Endoskopbrücke mit 1 Instrumentenkanal, passend zu Urethrotomschaft AI-001-001  
*Endoscope bridge with 1 instrument channel, fit with urethrotome sheath AI-001-001*



**Bestell-Nr.**  
**Ordering no.**

**964** **AI-001-002** Zusatzschaft für AI-001-001, seitlich offen  
*Sheath for AI-001-001, open to side*



**Bestell-Nr.**  
**Ordering no.**

**968** **AI-001-006** Zusatzschaft 25 Charr. für Dauerspülung  
*Supplementary sheath 25 Fr. for continuous flow*



**Bestell-Nr.  
Ordering no.**

966

**AI-001-004**

Standardobturator für Urethrotomschaft 21 Charr.  
Standard obturator for urethrotome sheath 21 Fr.



**Bestell-Nr.  
Ordering no.**

967

**AI-001-005**

Obturator für Urethrotomschaft 21 Charr. mit 5 Charr. Instrumentenkanal  
Obturator for urethrotome sheath 21 Fr. with 5 Fr. instrument channel



**Bestell-Nr.  
Ordering no.**

973

**AI-001-012**

Sichtobturator für Urethrotomschaft 21 Charr.  
Viewing obturator for urethrotome sheath 21 Fr.



**Bestell-Nr.  
Ordering no.**

	<b>AI-001-007</b> 969	Strikturmesser gerade Cold knife straight
	<b>AI-001-008</b> 970	Strikturmesser gerade, Wellenschliff Cold knife straight, wave shape
	<b>AI-001-009</b> 971	Strikturmesser rund Cold knife round
	<b>AI-001-011</b> 972	Strikturmesser hakenförmig Cold knife hook shaped



**Bestell-Nr.  
Ordering no.**

<b>AJ-010-006</b>	Schutzhülse aus Stahl zur Sterilisation und Aufbewahrung von Elektroden und Strikturmessern Protection sleeve made of steel for sterilization and storage of electrodes and cold knives
-------------------	--



**Bestell-Nr.**  
**Ordering no.**

**AA-003-001** Zystoskop Ø 2.9mm, Blickwinkel 0°, autoklavierbar  
*Cystoscope Ø 2.9mm, 0° viewing angle, autoclavable*

**AA-003-011** **HD** Zystoskop Ø 2.9mm, Blickwinkel 0°, autoklavierbar  
**HD** *Cystoscope Ø 2.9mm, 0° viewing angle, autoclavable*



**Bestell-Nr.**  
**Ordering no.**

9 **AI-005-001** Urethrotomschaft 15.5 Charr. mit Instrumentenkanal 3 Charr.  
*Urethrotome sheath 15.5 Fr. with instrument channel 3 Fr.*

99 **AI-005-003** Endoskopbrücke mit 1 Instrumentenkanal, passend zu Urethrotomschaft AI-005-001  
*Endoscope bridge with 1 instrument channel, fit with urethrotome sheath AI-005-001*



**Bestell-Nr.**  
**Ordering no.**

991 **AI-005-004** Standardobturator für Urethrotomschaft 15.5 Charr.  
*Standard obturator for urethrotome sheath 15.5 Fr.*



**Bestell-Nr.  
Ordering no.**

897

**AG-001-010**

Arbeitselement für Resektoskope, **passiv** schneidend, Griff geschlossen ohne HF-Anschluss  
Working element used for resectoscopes, **passive** cutting, handle closed without HF-connection



**Bestell-Nr.  
Ordering no.**



**AI-005-007 992** Strikturmesser gerade  
Cold knife straight



**AI-005-008 993** Strikturmesser gerade, Wellenschliff  
Cold knife straight, wave shape



**AI-005-011 994** Strikturmesser hakenförmig  
Cold knife hook shaped



	<b>Bestell-Nr.</b> <b>Ordering no.</b>	<b>Arbeitslänge</b> <b>Working length</b>	
35	<b>AA-006-001</b>	200mm	Nephroskop mit 45° abgewinkeltem Okular, Ø 7.45mm, Blickwinkel <b>0°</b> , Spülkanal Ø 1.5mm, Arbeitskanal Ø 4.7mm <i>Nephroscope with 45° angled ocular, Ø 7.45mm, viewing angle <b>0°</b>, suction channel Ø 1.5mm, working channel Ø 4.7mm</i>
42	<b>AA-006-021</b>	200mm	Nephroskop mit 45° abgewinkeltem Okular, Ø 7.45mm, Blickwinkel <b>6°</b> , Spülkanal Ø 1.5mm, Arbeitskanal Ø 4.7mm <i>Nephroscope with 45° angled ocular, Ø 7.45mm, viewing angle <b>6°</b>, suction channel Ø 1.5mm, working channel Ø 4.7mm</i>
37	<b>AA-006-004</b>	200mm	Nephroskop mit 45° abgewinkeltem Okular, Ø 7.45mm, Blickwinkel <b>15°</b> , Spülkanal Ø 1.5mm, Arbeitskanal Ø 4.7mm <i>Nephroscope with 45° angled ocular, Ø 7.45mm, viewing angle <b>15°</b>, suction channel Ø 1.5mm, working channel Ø 4.7mm</i>

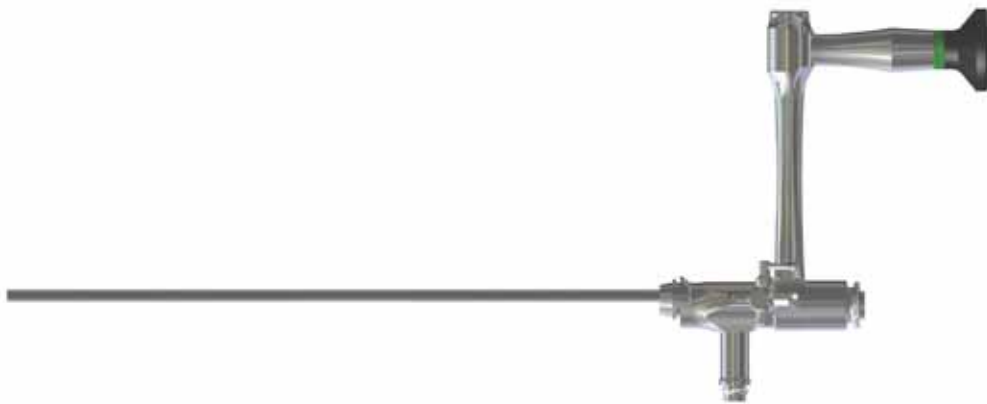

	<b>Bestell-Nr.</b> <b>Ordering no.</b>	<b>Arbeitslänge</b> <b>Working length</b>	
36	<b>AA-006-002</b>	200mm	Nephroskop mit 90° abgewinkeltem Okular, Ø 7.45mm, Blickwinkel <b>0°</b> , Spülkanal Ø 1.5mm, Arbeitskanal Ø 4.7mm <i>Nephroscope with 90° angled ocular, Ø 7.45mm, viewing angle <b>0°</b>, suction channel Ø 1.5mm, working channel Ø 4.7mm</i>
43	<b>AA-006-022</b>	200mm	Nephroskop mit 90° abgewinkeltem Okular, Ø 7.45mm, Blickwinkel <b>6°</b> , Spülkanal Ø 1.5mm, Arbeitskanal Ø 4.7mm <i>Nephroscope with 90° angled ocular, Ø 7.45mm, viewing angle <b>6°</b>, suction channel Ø 1.5mm, working channel Ø 4.7mm</i>
38	<b>AA-006-005</b>	200mm	Nephroskop mit 90° abgewinkeltem Okular, Ø 7.45mm, Blickwinkel <b>15°</b> , Spülkanal Ø 1.5mm, Arbeitskanal Ø 4.7mm <i>Nephroscope with 90° angled ocular, Ø 7.45mm, viewing angle <b>15°</b>, suction channel Ø 1.5mm, working channel Ø 4.7mm</i>





**Bestell-Nr.  
Ordering no.**

18	<b>AB-006-001</b>	Nephroskopschaft zur Dauerspülung, Hahn <u>drehbar</u> , <b>24</b> Charr. (passend für Nephroskope AL 200mm) Nephroscope sheath for continous flow, <u>rotatable</u> stopcock, <b>24</b> Fr. (fit with nephrosopes WL 200mm)
4	<b>AB-006-007</b>	Nephroskopschaft zur Dauerspülung, Hahn <u>drehbar</u> , <b>26</b> Charr. (passend für Nephroskope AL 200mm) Nephroscope sheath for continous flow, <u>rotatable</u> stopcock, <b>26</b> Fr. (fit with nephrosopes WL 200mm)
18	<b>AB-006-005</b>	Nephroskopschaft zur Dauerspülung, Hahn <u>feststehend</u> , <b>24</b> Charr. (passend für Nephroskope AL 200mm) Nephroscope sheath for continous flow, <u>fixed</u> stopcock, <b>24</b> Fr. (fit with all nephrosopes with WL 200mm)
2	<b>AB-006-006</b>	Nephroskopschaft zur Dauerspülung, Hahn <u>feststehend</u> , <b>26</b> Charr. (passend für Nephroskope AL 200mm) Nephroscope sheath for continous flow, <u>fixed</u> stopcock, <b>26</b> Fr. (fit with nephrosopes WL 200mm)



**Bestell-Nr.  
Ordering no.**

0	<b>AB-006-003</b>	Nephroskopschaft zur Dauerspülung, perforiert, Hahn <u>drehbar</u> , <b>26</b> Charr. (passend für Nephroskope AL 200mm) Nephroscope sheath for continous flow, perforated, <u>rotatable</u> stopcock, <b>26</b> Fr. (fit with nephrosopes WL 200mm)
18	<b>AB-006-008</b>	Nephroskopschaft zur Dauerspülung, perforiert, Hahn <u>feststehend</u> , <b>26</b> Charr. (passend für Nephroskope AL 200mm) Nephroscope sheath for continous flow, perforated, <u>fixed</u> stopcock, <b>26</b> Fr. (fit with nephrosopes WL 200mm)



**Bestell-Nr.  
Ordering no.**

9	<b>AB-006-002</b>	Obturator hohl 24 Charr. für 24 Charr. Nephroskopieschäfte (200mm) Obturator hollow 24 Fr. used for 24 Fr. nephroscopy sheaths (200mm)
18	<b>AB-006-004</b>	Obturator hohl 26 Charr. für 26 Charr. Nephroskopieschäfte (200mm) Obturator hollow 26 Fr. used for 26 Fr. nephroscopy sheaths (200mm)



	<b>Bestell-Nr.</b> <b>Ordering no.</b>	<b>Arbeitslänge</b> <b>Working length</b>	
U	<b>AA-006-011</b>	250mm	Nephroskop mit 45° abgewinkeltem Okular, Ø 7.45mm, Blickwinkel <b>0°</b> , Spülkanal Ø 1.5mm, Arbeitskanal Ø 4.7mm <i>Nephroscope with 45° angled ocular, Ø 7.45mm, viewing angle <b>0°</b>, suction channel Ø 1.5mm, working channel Ø 4.7mm</i>
4	<b>AA-006-031</b>	250mm	Nephroskop mit 45° abgewinkeltem Okular, Ø 7.45mm, Blickwinkel <b>6°</b> , Spülkanal Ø 1.5mm, Arbeitskanal Ø 4.7mm <i>Nephroscope with 45° angled ocular, Ø 7.45mm, viewing angle <b>6°</b>, suction channel Ø 1.5mm, working channel Ø 4.7mm</i>



	<b>Bestell-Nr.</b> <b>Ordering no.</b>	<b>Arbeitslänge</b> <b>Working length</b>	
	<b>AA-006-012</b>	250mm	Nephroskop mit 90° abgewinkeltem Okular, Ø 7.45mm, Blickwinkel <b>0°</b> , Spülkanal Ø 1.5mm, Arbeitskanal Ø 4.7mm <i>Nephroscope with 90° angled ocular, Ø 7.45mm, viewing angle <b>0°</b>, suction channel Ø 1.5mm, working channel Ø 4.7mm</i>
5	<b>AA-006-032</b>	250mm	Nephroskop mit 90° abgewinkeltem Okular, Ø 7.45mm, Blickwinkel <b>6°</b> , Spülkanal Ø 1.5mm, Arbeitskanal Ø 4.7mm <i>Nephroscope with 90° angled ocular, Ø 7.45mm, viewing angle <b>6°</b>, suction channel Ø 1.5mm, working channel Ø 4.7mm</i>
3	<b>AA-006-006</b>	250mm	Nephroskop mit 90° abgewinkeltem Okular, Ø 7.45mm, Blickwinkel <b>15°</b> , Spülkanal Ø 1.5mm, Arbeitskanal Ø 4.7mm <i>Nephroscope with 90° angled ocular, Ø 7.45mm, viewing angle <b>15°</b>, suction channel Ø 1.5mm, working channel Ø 4.7mm</i>



**Bestell-Nr.**  
**Ordering no.**

21	<b>AB-006-061</b>	Nephroskopschaft zur Dauerspülung, Hahn <u>drehbar</u> , <b>24</b> Charr. (passend für Nephroskope AL 250mm) <i>Nephroscope sheath for continous flow, <u>rotatable</u> stopcock, <b>24</b> Fr. (fit with nephrosopes WL 250mm)</i>
5	<b>AB-006-067</b>	Nephroskopschaft zur Dauerspülung, Hahn <u>drehbar</u> , <b>26</b> Charr. (passend für Nephroskope AL 250mm) <i>Nephroscope sheath for continous flow, <u>rotatable</u> stopcock, <b>26</b> Fr. (fit with nephrosopes WL 250mm)</i>
21	<b>AB-006-065</b>	Nephroskopschaft zur Dauerspülung, Hahn <u>feststehend</u> , <b>24</b> Charr. (passend für Nephroskope AL 250mm) <i>Nephroscope sheath for continous flow, <u>fixed</u> stopcock, <b>24</b> Fr. (fit with all nephrosopes with WL 250mm)</i>
3	<b>AB-006-066</b>	Nephroskopschaft zur Dauerspülung, Hahn <u>feststehend</u> , <b>26</b> Charr. (passend für Nephroskope AL 250mm) <i>Nephroscope sheath for continous flow, <u>fixed</u> stopcock, <b>26</b> Fr. (fit with nephrosopes WL 250mm)</i>



**Bestell-Nr.**  
**Ordering no.**

1	<b>AB-006-063</b>	Nephroskopschaft zur Dauerspülung, perforiert, Hahn <u>drehbar</u> , <b>26</b> Charr. (passend für Nephroskope AL 250mm) <i>Nephroscope sheath for continous flow, perforated, <u>rotatable</u> stopcock, <b>26</b> Fr. (fit with nephrosopes WL 250mm)</i>
21	<b>AB-006-068</b>	Nephroskopschaft zur Dauerspülung, perforiert, Hahn <u>feststehend</u> , <b>26</b> Charr. (passend für Nephroskope AL 250mm) <i>Nephroscope sheath for continous flow, perforated, <u>fixed</u> stopcock, <b>26</b> Fr. (fit with nephrosopes WL 250mm)</i>



**Bestell-Nr.**  
**Ordering no.**

0	<b>AB-006-062</b>	Obturator hohl 24 Charr. für 24 Charr. Nephroskopieschäfte (250mm) <i>Obturator hollow 24 Fr. used for 24 Fr. nephroscopy sheaths (250mm)</i>
21	<b>AB-006-064</b>	Obturator hohl 26 Charr. für 26 Charr. Nephroskopieschäfte (250mm) <i>Obturator hollow 26 Fr. used for 26 Fr. nephroscopy sheaths (250mm)</i>



<b>Bestell-Nr.</b>		
<b>Ordering no.</b>		
186	<b>AB-006-011</b>	Satz Teleskop-Bougies bestehend aus: 6 Dilatationshülsen 9, 12, 15, 18, 21 und 24 Charr. mit 1 starren und 1 flexiblen Führungssonde <i>Set of telescope bougies consisting of: 6 dilating bougies 9, 12, 15, 18, 21 and 24 Fr., incl. 1 rigid and 1 flexible guide probe</i>
9	<b>AB-006-012</b>	Führungssonde, <b>starr</b> <i>Guide probe, <b>rigid</b></i>
19	<b>AB-006-013</b>	Führungssonde, <b>flexibel</b> <i>Guide probe, <b>flexible</b></i>
0	<b>AB-006-020</b>	Dilatationshülse <b>9</b> Charr. <i>Dilatating sheath <b>9</b> Fr.</i>
19	<b>AB-006-021</b>	Dilatationshülse <b>12</b> Charr. <i>Dilatating sheath <b>12</b> Fr.</i>
1	<b>AB-006-022</b>	Dilatationshülse <b>15</b> Charr. <i>Dilatating sheath <b>15</b> Fr.</i>
19	<b>AB-006-023</b>	Dilatationshülse <b>18</b> Charr. <i>Dilatating sheath <b>18</b> Fr.</i>
2	<b>AB-006-024</b>	Dilatationshülse <b>21</b> Charr. <i>Dilatating sheath <b>21</b> Fr.</i>
19	<b>AB-006-025</b>	Dilatationshülse <b>24</b> Charr. <i>Dilatating sheath <b>24</b> Fr.</i>
3	<b>AB-006-026</b>	Dilatationshülse <b>27</b> Charr. <i>Dilatating sheath <b>27</b> Fr.</i>
19	<b>AB-006-027</b>	Dilatationshülse <b>30</b> Charr. <i>Dilatating sheath <b>30</b> Fr.</i>

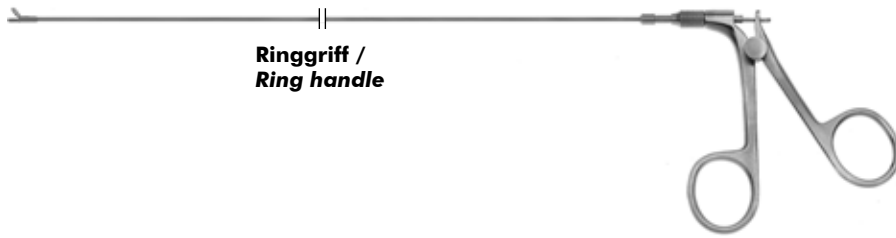

	Bestell-Nr. Ordering no.	Arbeitslänge Working length	Ømm	
	AB-006-046 203	380mm	3.5	Steinfaßzange mit gefensterem Maul, <b>Federgriff</b> Fenestrated stone grasping forceps, <b>U-spring handle</b>
	AB-006-048 205	380mm	3.5	Steinfaßzange mit gefensterem Maul, <b>Ringgriff</b> Fenestrated stone grasping forceps, <b>ring handle</b>
	AB-006-040 197	430mm	3.5	Steinfaßzange mit gefensterem Maul, <b>Federgriff</b> Fenestrated stone grasping forceps, <b>U-spring handle</b>
	AB-006-042 199	430mm	3.5	Steinfaßzange mit gefensterem Maul, <b>Ringgriff</b> Fenestrated stone grasping forceps, <b>ring handle</b>
	AB-006-047 204	380mm	3.5	Dreiarmsgreifer für grosse Steine, <b>Federgriff</b> 3-Prongs retriever for larger stones, <b>U-spring handle</b>
	AB-006-041 198	430mm	3.5	Dreiarmsgreifer für grosse Steine, <b>Federgriff</b> 3-Prongs retriever for larger stones, <b>U-spring handle</b>
	AB-006-049 206	380mm	3.5	Probeexcisionszange mit <b>Ringgriff</b> , einfachbeweglich Biopsy forceps with <b>ring handle</b> , single action
	AB-006-043 200	430mm	3.5	Probeexcisionszange mit <b>Ringgriff</b> , einfachbeweglich Biopsy forceps with <b>ring handle</b> , single action
	AB-006-050 207	380mm	3.5	Alligatorfaßzange mit <b>Ringgriff</b> Alligator grasping forceps with <b>ring handle</b>
	AB-006-044 201	430mm	3.5	Alligatorfaßzange mit <b>Ringgriff</b> Alligator grasping forceps with <b>ring handle</b>
	AB-006-051 208	380mm	3.5	Schere mit <b>Ringgriff</b> , einfachbeweglich Scissors with <b>ring handle</b> , single action
	AB-006-045 202	430mm	3.5	Schere mit <b>Ringgriff</b> , einfachbeweglich Scissors with <b>ring handle</b> , single action

**STEMA High Definition**



	<b>Bestell-Nr.</b> <b>Ordering no.</b>	<b>Arbeitslänge</b> <b>Working length</b>	
50	<b>AA-006-069</b>	220mm	HD Nephroskop mit 45° abgewinkeltem Okular, Ø 18.8 Ch., Blickwinkel <b>0°</b> , Arbeitskanal Ø 12.9 Ch. <i>HD nephroscope with 45° angled ocular, Ø 18.8 Fr., viewing angle <b>0°</b>, working channel Ø 12.9 Fr.</i>
51	<b>AA-006-070</b>	220mm	HD Nephroskop mit 45° abgewinkeltem Okular, Ø 18.8 Ch., Blickwinkel <b>15°</b> , Arbeitskanal Ø 12.9 Ch. <i>HD nephroscope with 45° angled ocular, Ø 18.8 Fr., viewing angle <b>15°</b>, working channel Ø 12.9 Fr.</i>







<b>Bestell-Nr.</b> <b>Ordering no.</b>	
<b>AB-006-168</b>	Nephroskopschaft zur Dauerspülung, Hahn drehbar, <b>23</b> Charr. (passend für Nephroskope AL 220mm / Optik 0°) <i>Nephroscope sheath for continuous flow, rotatable stopcock, <b>23</b> Fr. (fit with nephoscopes WL 220mm / scope 0°)</i>
<b>AB-006-170</b>	Nephroskopschaft zur Dauerspülung, Hahn drehbar, <b>23</b> Charr. (passend für Nephroskope AL 220mm / Optik 15°) <i>Nephroscope sheath for continuous flow, rotatable stopcock, <b>23</b> Fr. (fit with nephoscopes WL 220mm / scope 15°)</i>

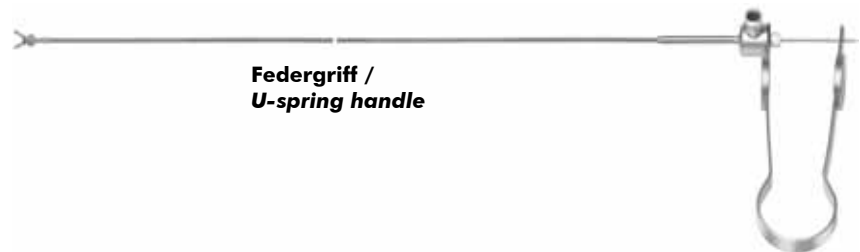
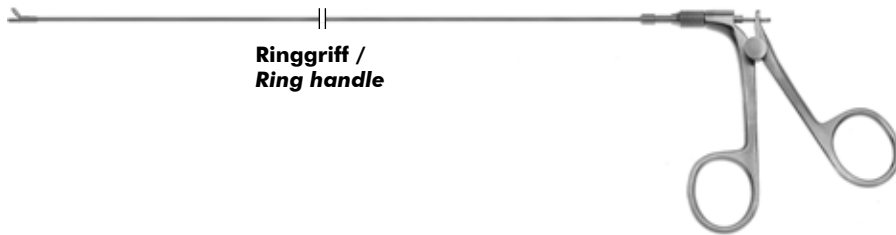

<b>Bestell-Nr.</b> <b>Ordering no.</b>	
<b>AB-006-169</b>	Obturator hohl, <b>23</b> Charr. (passend für Nephroskopieschaft AB-006-168 / Optik 0°) <i>Obturator hollow, <b>23</b> Fr. (fit with nephroscopy sheath AB-006-168 / scope 0°)</i>
<b>AB-006-171</b>	Obturator hohl, <b>23</b> Charr. (passend für Nephroskopieschaft AB-006-170 / Optik 15°) <i>Obturator hollow, <b>23</b> Fr. (fit with nephroscopy sheath AB-006-170 / scope 15°)</i>

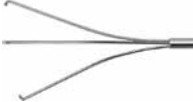

	Bestell-Nr. Ordering no.	Arbeitslänge Working length	Ømm	
	<b>AB-006-443</b> 225	400mm	3.0	Probeexzisionszange oval, doppelbeweglich, starr <i>Biopsy forceps oval, double action, rigid</i>
	<b>AB-006-442</b> 224	400mm	3.0	Steinfaßzange mit gefensterterem Maul, doppelbeweglich, starr <i>Fenestrated stone grasping forceps, double action, rigid</i>
	<b>AB-006-444</b> 226	400mm	3.0	Fasszange Alligatormaul, doppelbeweglich, starr <i>Grasping forceps alligator jaw, double action, rigid</i>
	<b>AB-006-445</b> 227	500mm	3.0	Schere spitz, einfachbeweglich <i>Scissors pointed, single action</i>
	<b>AB-006-446</b> 228	400mm	3.0	Dreiarmgreifer, starr, mit Federgriff <i>3-Prongs retriever, rigid, with U-spring handle</i>

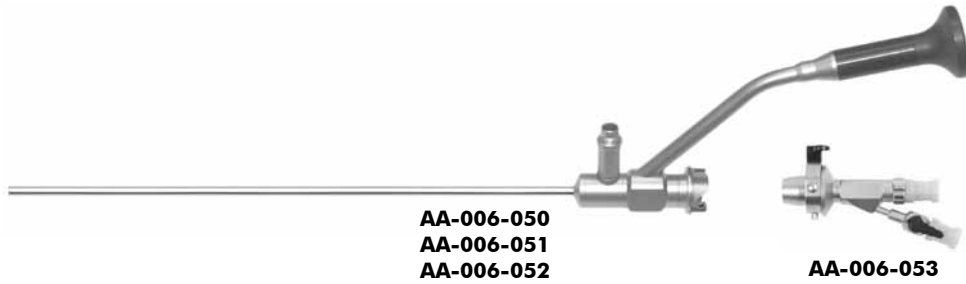

4  
7

Bestell-Nr. Ordering no.	Arbeitslänge Working length	
AA-006-050	220mm	Mini-Nephroskop mit 45° abgewinkeltem Okular, Ø 19 Charr., Blickwinkel 8°, Arbeitskanal 10 Charr. <i>Mini nephroscope with 45° angled ocular, Ø 19 Fr., viewing angle 8°, instrument channel 10 Fr.</i>
AA-006-051	220mm	Mini-Nephroskop mit 45° abgewinkeltem Okular, Ø 13.5 Charr., Blickwinkel 8°, Arbeitskanal 6 Charr. <i>Mini nephroscope with 45° angled ocular, Ø 13.5 Fr., viewing angle 8°, instrument channel 6 Fr.</i>
AA-006-052	320mm	Mini-Nephroskop mit 45° abgewinkeltem Okular, Ø 13.5 Charr., Blickwinkel 8°, Arbeitskanal 6 Charr. <i>Mini nephroscope with 45° angled ocular, Ø 13.5 Fr., viewing angle 8°, instrument channel 6 Fr.</i>

49

Bestell-Nr. Ordering no.	
AA-006-053	Instrumentenbrücke für Mini-Nephroskope - <b>ACHTUNG:</b> Nicht im Lieferumfang enthalten! Bitte zusätzlich bestellen. <i>Instrument bridge used for Mini-Nephroskope - <b>ATTENTION:</b> Not included in the delivery content! Please order additionally.</i>



21  
8

Bestell-Nr. Ordering no.	Farbmarkierung Colour code	
AB-006-100	Rot Red	Mini-Nephroskopschäfte ohne Perforation zur Dauerspülung, Hahn fest, 15/18 Charr. <i>Mini nephroscope sheath without perforation, continuous flow, stopcock fixed, 15/18 Fr.</i>
AB-006-101	Blau Blue	Mini-Nephroskopschäfte ohne Perforation zur Dauerspülung, Hahn fest, 16.5/19.5 Charr. <i>Mini nephroscope sheath without perforation, continuous flow, stopcock fixed, 16.5/19.5 Fr.</i>
AB-006-102	Grün Green	Mini-Nephroskopschäfte ohne Perforation zur Dauerspülung, Hahn fest, 21/24 Charr. <i>Mini nephroscope sheath without perforation, continuous flow, stopcock fixed, 21/24 Fr.</i>



22  
1

Bestell-Nr. Ordering no.	
AB-006-110	Dilatator 15/18 Charr. mit zentraler Bohrung Ø 3 Charr. <i>Dilatator 15/18 Fr. with central cannulation Ø 3 Fr.</i>
AB-006-111	Dilatator 16/19.5 Charr. mit 2 Kanälen Ø 2x3 Charr. <i>Dilatator 16/19.5 Fr. with 2 channels Ø 2x3 Fr.</i>
AB-006-112	Dilatator 21/24 Charr. mit 2 Kanälen Ø 2x5 Charr. <i>Dilatator 21/24 Fr. with 2 channels Ø 2x5 Fr.</i>

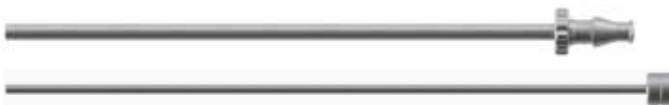

223

Bestell-Nr. Ordering no.	
AB-006-115	Applikator für die Benutzung der Mini-Nephroskopschäfte, inkl. Stößel <i>Applicator used for the mini nephroscope sheaths, incl. plunger</i>



**STEMA** **High Definition**



**Bestell-Nr.**  
**Ordering no.**

52

**AA-006-100**

Mini HD Kompakt-Nephroskop mit 30° abgewinkeltem Okular, Schaft 12 Charr., Blickwinkel 0°, Arbeitslänge 220mm, Instrumentenkanal 6.6 Charr., 3 Luer-Lock Anschlüsse, 40.000 Pixel  
*Mini HD compact nephroscope with 30° angled ocular, sheath 12 Fr., viewing angle 0°, working length 220mm, instrument channel 6.6 Fr., 3 luerlock connections, 40.000 pixel*

53

**AA-006-101**

Mini HD Kompakt-Nephroskop mit 30° abgewinkeltem Okular, Schaft 9 Charr., Blickwinkel 0°, Arbeitslänge 220mm, Instrumentenkanal 4.8 Charr., 3 Luer-Lock Anschlüsse, 17.000 Pixel  
*Mini HD compact nephroscope with 30° angled ocular, sheath 9 Fr., viewing angle 0°, working length 220mm, instrument channel 4.8 Fr., 3 luerlock connections, 17.000 pixel*

54

**AA-006-102**

Mini HD Kompakt-Nephroskop mit 30° abgewinkeltem Okular, Schaft 8.1 Charr., Blickwinkel 0°, Arbeitslänge 220mm, Instrumentenkanal 3.6 Charr., 3 Luer-Lock Anschlüsse, 17.000 Pixel  
*Mini HD compact nephroscope with 30° angled ocular, sheath 8.1 Fr., viewing angle 0°, working length 220mm, instrument channel 3.6 Fr., 3 luerlock connections, 17.000 pixel*



	<b>Bestell-Nr.</b> <b>Ordering no.</b>	<b>Arbeitslänge</b> <b>Working length</b>	
55	<b>AA-007-001</b>	310mm	Halbstarres Uretero-Renoskop mit 45° abgewinkeltem Okular, Ø stufenförmig von <b>9.5</b> bis <b>10.5</b> Charr., Blickwinkel 8°, Arbeitskanal <b>5</b> Charr. <i>Semirigid uretero-renaloscope with 45° angled ocular, Ø steps from <b>9.5</b> to <b>10.5</b> Fr., viewing angle 8°, instrument channel <b>5</b> Fr.</i>
64	<b>AA-007-011</b>	310mm	Halbstarres Uretero-Renoskop mit 45° abgewinkeltem Okular, Ø stufenförmig von <b>6.0</b> bis <b>7.5</b> Charr., Blickwinkel 8°, Arbeitskanal <b>4</b> Charr. <i>Semirigid uretero-renaloscope with 45° angled ocular, Ø steps from <b>6.0</b> to <b>7.5</b> Fr., viewing angle 8°, instrument channel <b>4</b> Fr.</i>
56	<b>AA-007-002</b>	425mm	Halbstarres Uretero-Renoskop mit 45° abgewinkeltem Okular, Ø stufenförmig von <b>9.5</b> bis <b>10.5</b> Charr., Blickwinkel 8°, Arbeitskanal <b>5</b> Charr. <i>Semirigid uretero-renaloscope with 45° angled ocular, Ø steps from <b>9.5</b> to <b>10.5</b> Fr., viewing angle 8°, instrument channel <b>5</b> Fr.</i>
65	<b>AA-007-012</b>	425mm	Halbstarres Uretero-Renoskop mit 45° abgewinkeltem Okular, Ø stufenförmig von <b>6.0</b> bis <b>7.5</b> Charr., Blickwinkel 8°, Arbeitskanal <b>4</b> Charr. <i>Semirigid uretero-renaloscope with 45° angled ocular, Ø steps from <b>6.0</b> to <b>7.5</b> Fr., viewing angle 8°, instrument channel <b>4</b> Fr.</i>



	<b>Bestell-Nr. Ordering no.</b>	<b>Arbeitslänge Working length</b>	
104	<b>AA-007-056</b>	310mm	BICHLER halbstarres Uretero-Renoskop mit 45° abgewinkeltem Okular, Ø stufenförmig von <b>4.5 bis 6.5</b> Charr., Blickwinkel 12°, Arbeitskanal <b>1 x 3.3</b> Charr. <i>BICHLER semirigid uretero-rensoscope with 45° angled ocular, Ø steps from 4.5 to 6.5 Fr., viewing angle 12°, working channel 1 x 3.3 Fr.</i>
103	<b>AA-007-055</b>	430mm	BICHLER halbstarres Uretero-Renoskop mit 45° abgewinkeltem Okular, Ø stufenförmig von <b>4.5 bis 6.5</b> Charr., Blickwinkel 12°, Arbeitskanal <b>1 x 3.3</b> Charr. <i>BICHLER semirigid uretero-rensoscope with 45° angled ocular, Ø steps from 4.5 to 6.5 Fr., viewing angle 12°, working channel 1 x 3.3 Fr.</i>
91	<b>AA-007-043</b>	310mm	BICHLER halbstarres Uretero-Renoskop mit 45° abgewinkeltem Okular, Ø stufenförmig von <b>6.0 bis 7.5</b> Charr., Blickwinkel 12°, Arbeitskanal <b>1 x 4</b> Charr. oder <b>2 x 2.4</b> Charr. <i>BICHLER semirigid uretero-rensoscope with 45° angled ocular, Ø steps from 6.0 to 7.5 Fr., viewing angle 12°, working channel 1 x 4 Fr. or 2 x 2.4 Fr.</i>
92	<b>AA-007-044</b>	430mm	BICHLER halbstarres Uretero-Renoskop mit 45° abgewinkeltem Okular, Ø stufenförmig von <b>6.0 bis 7.5</b> Charr., Blickwinkel 12°, Arbeitskanal <b>1 x 4</b> Charr. oder <b>2 x 2.4</b> Charr. <i>BICHLER semirigid uretero-rensoscope with 45° angled ocular, Ø steps from 6.0 to 7.5 Fr., viewing angle 12°, working channel 1 x 4 Fr. or 2 x 2.4 Fr.</i>
95	<b>AA-007-047</b>	310mm	BICHLER halbstarres Uretero-Renoskop mit 45° abgewinkeltem Okular, Ø stufenförmig von <b>8.0 bis 9.8</b> Charr., Blickwinkel 12°, Arbeitskanal <b>1 x 5</b> Charr. oder <b>2 x 3</b> Charr. <i>BICHLER semirigid uretero-rensoscope with 45° angled ocular, Ø steps from 8.0 to 9.8 Fr., viewing angle 12°, working channel 1 x 5 Fr. or 2 x 3 Fr.</i>
96	<b>AA-007-048</b>	430mm	BICHLER halbstarres Uretero-Renoskop mit 45° abgewinkeltem Okular, Ø stufenförmig von <b>8.0 bis 9.8</b> Charr., Blickwinkel 12°, Arbeitskanal <b>1 x 5</b> Charr. oder <b>2 x 3</b> Charr. <i>BICHLER semirigid uretero-rensoscope with 45° angled ocular, Ø steps from 8.0 to 9.8 Fr., viewing angle 12°, working channel 1 x 5 Fr. or 2 x 3 Fr.</i>
99	<b>AA-007-051</b>	310mm	BICHLER halbstarres Uretero-Renoskop mit 45° abgewinkeltem Okular, Ø stufenförmig von <b>8.5 bis 11.5</b> Charr., Blickwinkel 12°, Arbeitskanal <b>1 x 6</b> Charr. oder <b>2 x 4</b> Charr. <i>BICHLER semirigid uretero-rensoscope with 45° angled ocular, Ø steps from 8.5 to 11.5 Fr., viewing angle 12°, working channel 1 x 6 Fr. or 2 x 4 Fr.</i>
100	<b>AA-007-052</b>	430mm	BICHLER halbstarres Uretero-Renoskop mit 45° abgewinkeltem Okular, Ø stufenförmig von <b>8.5 bis 11.5</b> Charr., Blickwinkel 12°, Arbeitskanal <b>1 x 6</b> Charr. oder <b>2 x 4</b> Charr. <i>BICHLER semirigid uretero-rensoscope with 45° angled ocular, Ø steps from 8.5 to 11.5 Fr., viewing angle 12°, working channel 1 x 6 Fr. or 2 x 4 Fr.</i>



	<b>Bestell-Nr.</b> <b>Ordering no.</b>	<b>Arbeitslänge</b> <b>Working length</b>	
102	<b>AA-007-054</b>	310mm	MARBERGER halbstarres Uretero-Renoskop mit 45° abgewinkeltem Okular, Ø stufenförmig von <b>4.5 bis 6.5</b> Charr., Blickwinkel 5°, Arbeitskanal <b>1 x 3.3</b> Charr. <i>MARBERGER semirigid uretero-renaloscope with 45° angled ocular, Ø steps from 4.5 to 6.5 Fr., viewing angle 5°, instrument channel 1 x 3.3 Fr.</i>
101	<b>AA-007-053</b>	430mm	MARBERGER halbstarres Uretero-Renoskop mit 45° abgewinkeltem Okular, Ø stufenförmig von <b>4.5 bis 6.5</b> Charr., Blickwinkel 5°, Arbeitskanal <b>1 x 3.3</b> Charr. <i>MARBERGER semirigid uretero-renaloscope with 45° angled ocular, Ø steps from 4.5 to 6.5 Fr., viewing angle 5°, instrument channel 1 x 3.3 Fr.</i>
89	<b>AA-007-041</b>	310mm	MARBERGER halbstarres Uretero-Renoskop mit 45° abgewinkeltem Okular, Ø stufenförmig von <b>6.0 bis 7.5</b> Charr., Blickwinkel 12°, Arbeitskanal <b>1 x 4</b> Charr. oder <b>2 x 2.4</b> Charr. <i>MARBERGER semirigid uretero-renaloscope with 45° angled ocular, Ø steps from 6.0 to 7.5 Fr., viewing angle 12°, instrument channel 1 x 4 Fr. or 2 x 2.4 Fr.</i>
90	<b>AA-007-042</b>	430mm	MARBERGER halbstarres Uretero-Renoskop mit 45° abgewinkeltem Okular, Ø stufenförmig von <b>6.0 bis 7.5</b> Charr., Blickwinkel 12°, Arbeitskanal <b>1 x 4</b> Charr. oder <b>2 x 2.4</b> Charr. <i>MARBERGER semirigid uretero-renaloscope with 45° angled ocular, Ø steps from 6.0 to 7.5 Fr., viewing angle 12°, instrument channel 1 x 4 Fr. or 2 x 2.4 Fr.</i>
93	<b>AA-007-045</b>	310mm	MARBERGER halbstarres Uretero-Renoskop mit 45° abgewinkeltem Okular, Ø stufenförmig von <b>8.0 bis 9.8</b> Charr., Blickwinkel 12°, Arbeitskanal <b>1 x 5</b> Charr. oder <b>2 x 3</b> Charr. <i>MARBERGER semirigid uretero-renaloscope with 45° angled ocular, Ø steps from 8.0 to 9.8 Fr., viewing angle 12°, instrument channel 1 x 5 Fr. or 2 x 3 Fr.</i>
94	<b>AA-007-046</b>	430mm	MARBERGER halbstarres Uretero-Renoskop mit 45° abgewinkeltem Okular, Ø stufenförmig von <b>8.0 bis 9.8</b> Charr., Blickwinkel 12°, Arbeitskanal <b>1 x 5</b> Charr. oder <b>2 x 3</b> Charr. <i>MARBERGER semirigid uretero-renaloscope with 45° angled ocular, Ø steps from 8.0 to 9.8 Fr., viewing angle 12°, instrument channel 1 x 5 Fr. or 2 x 3 Fr.</i>
97	<b>AA-007-049</b>	310mm	MARBERGER halbstarres Uretero-Renoskop mit 45° abgewinkeltem Okular, Ø stufenförmig von <b>8.5 bis 11.5</b> Charr., Blickwinkel 12°, Arbeitskanal <b>1 x 6</b> Charr. oder <b>2 x 4</b> Charr. <i>MARBERGER semirigid uretero-renaloscope with 45° angled ocular, Ø steps from 8.5 to 11.5 Fr., viewing angle 12°, instrument channel 1 x 6 Fr. or 2 x 4 Fr.</i>
98	<b>AA-007-050</b>	430mm	MARBERGER halbstarres Uretero-Renoskop mit 45° abgewinkeltem Okular, Ø stufenförmig von <b>8.5 bis 11.5</b> Charr., Blickwinkel 12°, Arbeitskanal <b>1 x 6</b> Charr. oder <b>2 x 4</b> Charr. <i>MARBERGER semirigid uretero-renaloscope with 45° angled ocular, Ø steps from 8.5 to 11.5 Fr., viewing angle 12°, instrument channel 1 x 6 Fr. or 2 x 4 Fr.</i>

**STEMA High Definition**



Bestell-Nr. Ordering no.	Arbeitslänge Working length	
57 <b>AA-007-003</b>	425mm	HD Halbstarres Uretero-Renoskop mit 45° abgewinkeltem Okular, Ø stufenförmig 7.5 bis 12 Charr., Blickwinkel <b>0°</b> , Arbeitskanal 1 x 5 Charr. oder 2 x 3 Charr., 40.000 Pixel <i>HD Semirigid uretero-rensoscopy with 45° angled ocular, Ø steps by 7.5 to 12 Fr., viewing angle <b>0°</b>, working channel 1 x 5 Fr. or 2 x 3 Fr., 40.000 pixel</i>
69 <b>AA-007-016</b>	425mm	HD Halbstarres Uretero-Renoskop mit 45° abgewinkeltem Okular, Ø stufenförmig 7.5 bis 12 Charr., Blickwinkel <b>5°</b> , Arbeitskanal 1 x 5 Charr. oder 2 x 3 Charr., 40.000 Pixel <i>HD Semirigid uretero-rensoscopy with 45° angled ocular, Ø steps by 7.5 to 12 Fr., viewing angle <b>5°</b>, working channel 1 x 5 Fr. or 2 x 3 Fr., 40.000 pixel</i>
70 <b>AA-007-017</b>	425mm	HD Halbstarres Uretero-Renoskop mit 45° abgewinkeltem Okular, Ø stufenförmig 7.5 bis 12 Charr., Blickwinkel <b>12°</b> , Arbeitskanal 1 x 5 Charr. oder 2 x 3 Charr., 40.000 Pixel <i>HD Semirigid uretero-rensoscopy with 45° angled ocular, Ø steps by 7.5 to 12 Fr., viewing angle <b>12°</b>, working channel 1 x 5 Fr. or 2 x 3 Fr., 40.000 pixel</i>
58 <b>AA-007-004</b>	310mm	HD Halbstarres Uretero-Renoskop mit 45° abgewinkeltem Okular, Ø stufenförmig 7.5 bis 12 Charr., Blickwinkel <b>0°</b> , Arbeitskanal 1 x 5 Charr. oder 2 x 3 Charr., 40.000 Pixel <i>HD Semirigid uretero-rensoscopy with 45° angled ocular, Ø steps by 7.5 to 12 Fr., viewing angle <b>0°</b>, working channel 1 x 5 Fr. or 2 x 3 Fr., 40.000 pixel</i>
71 <b>AA-007-018</b>	310mm	HD Halbstarres Uretero-Renoskop mit 45° abgewinkeltem Okular, Ø stufenförmig 7.5 bis 12 Charr., Blickwinkel <b>5°</b> , Arbeitskanal 1 x 5 Charr. oder 2 x 3 Charr., 40.000 Pixel <i>HD Semirigid uretero-rensoscopy with 45° angled ocular, Ø steps by 7.5 to 12 Fr., viewing angle <b>5°</b>, working channel 1 x 5 Fr. or 2 x 3 Fr., 40.000 pixel</i>
72 <b>AA-007-019</b>	310mm	HD Halbstarres Uretero-Renoskop mit 45° abgewinkeltem Okular, Ø stufenförmig 7.5 bis 12 Charr., Blickwinkel <b>12°</b> , Arbeitskanal 1 x 5 Charr. oder 2 x 3 Charr., 40.000 Pixel <i>HD Semirigid uretero-rensoscopy with 45° angled ocular, Ø steps by 7.5 to 12 Fr., viewing angle <b>12°</b>, working channel 1 x 5 Fr. or 2 x 3 Fr., 40.000 pixel</i>
59 <b>AA-007-005</b>	150mm	HD Halbstarres Uretero-Renoskop mit 45° abgewinkeltem Okular, Ø stufenförmig 7.5 bis 12 Charr., Blickwinkel <b>0°</b> , Arbeitskanal 1 x 5 Charr. oder 2 x 3 Charr., 40.000 Pixel <i>HD Semirigid uretero-rensoscopy with 45° angled ocular, Ø steps by 7.5 to 12 Fr., viewing angle <b>0°</b>, working channel 1 x 5 Fr. or 2 x 3 Fr., 40.000 pixel</i>
87 <b>AA-007-036</b>	150mm	HD Halbstarres Uretero-Renoskop mit 45° abgewinkeltem Okular, Ø stufenförmig 7.5 bis 12 Charr., Blickwinkel <b>5°</b> , Arbeitskanal 1 x 5 Charr. oder 2 x 3 Charr., 40.000 Pixel <i>HD Semirigid uretero-rensoscopy with 45° angled ocular, Ø steps by 7.5 to 12 Fr., viewing angle <b>5°</b>, working channel 1 x 5 Fr. or 2 x 3 Fr., 40.000 pixel</i>
88 <b>AA-007-037</b>	150mm	HD Halbstarres Uretero-Renoskop mit 45° abgewinkeltem Okular, Ø stufenförmig 7.5 bis 12 Charr., Blickwinkel <b>12°</b> , Arbeitskanal 1 x 5 Charr. oder 2 x 3 Charr., 40.000 Pixel <i>HD Semirigid uretero-rensoscopy with 45° angled ocular, Ø steps by 7.5 to 12 Fr., viewing angle <b>12°</b>, working channel 1 x 5 Fr. or 2 x 3 Fr., 40.000 pixel</i>

**Im Lieferumfang enthalten**  
**Delivery contains**

HD Uretero-Renoskop, Bürste Ø 3.0mm (Länge 590mm), Bürste Ø 3.8mm (Länge 350mm), Dichtungskappe Silikon (grau), Duckbill Dichtung  
*HD uretero-rensoscopy, brush Ø 3.0mm (length 590mm), brush Ø 3.8mm (length 350mm), sealing cap silicone (grey), Duckbill sealing*

**STEMA High Definition**



Bestell-Nr. Ordering no.	Arbeitslänge Working length	
68 AA-007-015	425mm	HD Halbstarres Uretero-Renoskop mit 45° abgewinkeltem Okular, Ø stufenförmig 6 bis 7.5 Charr., Blickwinkel <b>0°</b> , Arbeitskanal 1 x 4 Charr. oder 2 x 2.4 Charr., 40.000 Pixel <i>HD Semirigid uretero-roscope with 45° angled ocular, Ø steps by 6 to 7.5 Fr., viewing angle <b>0°</b>, working channel 1 x 4 Fr. or 2 x 2.4 Fr., 40.000 pixel</i>
85 AA-007-034	425mm	HD Halbstarres Uretero-Renoskop mit 45° abgewinkeltem Okular, Ø stufenförmig 6 bis 7.5 Charr., Blickwinkel <b>5°</b> , Arbeitskanal 1 x 4 Charr. oder 2 x 2.4 Charr., 40.000 Pixel <i>HD Semirigid uretero-roscope with 45° angled ocular, Ø steps by 6 to 7.5 Fr., viewing angle <b>5°</b>, working channel 1 x 4 Fr. or 2 x 2.4 Fr., 40.000 pixel</i>
86 AA-007-035	425mm	HD Halbstarres Uretero-Renoskop mit 45° abgewinkeltem Okular, Ø stufenförmig 6 bis 7.5 Charr., Blickwinkel <b>12°</b> , Arbeitskanal 1 x 4 Charr. oder 2 x 2.4 Charr., 40.000 Pixel <i>HD Semirigid uretero-roscope with 45° angled ocular, Ø steps by 6 to 7.5 Fr., viewing angle <b>12°</b>, working channel 1 x 4 Fr. or 2 x 2.4 Fr., 40.000 pixel</i>
67 AA-007-014	310mm	HD Halbstarres Uretero-Renoskop mit 45° abgewinkeltem Okular, Ø stufenförmig 6 bis 7.5 Charr., Blickwinkel <b>0°</b> , Arbeitskanal 1 x 4 Charr. oder 2 x 2.4 Charr., 40.000 Pixel <i>HD Semirigid uretero-roscope with 45° angled ocular, Ø steps by 6 to 7.5 Fr., viewing angle <b>0°</b>, working channel 1 x 4 Fr. or 2 x 2.4 Fr., 40.000 pixel</i>
83 AA-007-032	310mm	HD Halbstarres Uretero-Renoskop mit 45° abgewinkeltem Okular, Ø stufenförmig 6 bis 7.5 Charr., Blickwinkel <b>5°</b> , Arbeitskanal 1 x 4 Charr. oder 2 x 2.4 Charr., 40.000 Pixel <i>HD Semirigid uretero-roscope with 45° angled ocular, Ø steps by 6 to 7.5 Fr., viewing angle <b>5°</b>, working channel 1 x 4 Fr. or 2 x 2.4 Fr., 40.000 pixel</i>
84 AA-007-033	310mm	HD Halbstarres Uretero-Renoskop mit 45° abgewinkeltem Okular, Ø stufenförmig 6 bis 7.5 Charr., Blickwinkel <b>12°</b> , Arbeitskanal 1 x 4 Charr. oder 2 x 2.4 Charr., 40.000 Pixel <i>HD Semirigid uretero-roscope with 45° angled ocular, Ø steps by 6 to 7.5 Fr., viewing angle <b>12°</b>, working channel 1 x 4 Fr. or 2 x 2.4 Fr., 40.000 pixel</i>
66 AA-007-013	140mm	HD Halbstarres Uretero-Renoskop mit 45° abgewinkeltem Okular, Ø stufenförmig 6 bis 7.5 Charr., Blickwinkel <b>0°</b> , Arbeitskanal 1 x 4 Charr. oder 2 x 2.4 Charr., 40.000 Pixel <i>HD Semirigid uretero-roscope with 45° angled ocular, Ø steps by 6 to 7.5 Fr., viewing angle <b>0°</b>, working channel 1 x 4 Fr. or 2 x 2.4 Fr., 40.000 pixel</i>
81 AA-007-030	140mm	HD Halbstarres Uretero-Renoskop mit 45° abgewinkeltem Okular, Ø stufenförmig 6 bis 7.5 Charr., Blickwinkel <b>5°</b> , Arbeitskanal 1 x 4 Charr. oder 2 x 2.4 Charr., 40.000 Pixel <i>HD Semirigid uretero-roscope with 45° angled ocular, Ø steps by 6 to 7.5 Fr., viewing angle <b>5°</b>, working channel 1 x 4 Fr. or 2 x 2.4 Fr., 40.000 pixel</i>
82 AA-007-031	140mm	HD Halbstarres Uretero-Renoskop mit 45° abgewinkeltem Okular, Ø stufenförmig 6 bis 7.5 Charr., Blickwinkel <b>12°</b> , Arbeitskanal 1 x 4 Charr. oder 2 x 2.4 Charr., 40.000 Pixel <i>HD Semirigid uretero-roscope with 45° angled ocular, Ø steps by 6 to 7.5 Fr., viewing angle <b>12°</b>, working channel 1 x 4 Fr. or 2 x 2.4 Fr., 40.000 pixel</i>

**Im Lieferumfang enthalten**  
**Delivery contains**

HD Uretero-Renoskop, Bürste Ø 3.0mm (Länge 590mm), Bürste Ø 3.8mm (Länge 350mm), Dichtungskappe Silikon (grau), Duckbill Dichtung  
*HD uretero-roscope, brush Ø 3.0mm (length 590mm), brush Ø 3.8mm (length 350mm), sealing cap silicone (grey), Duckbill sealing*

**STEMA High Definition**



Bestell-Nr. Ordering no.	Arbeitslänge Working length	
60 AA-007-006	425mm	HD Halbstarres Uretero-Renoskop mit 45° abgewinkeltem Okular, Ø stufenförmig 4.9 bis 6.5 Charr., Blickwinkel 0°, Arbeitskanal 1 x 3 Charr., 40.000 Pixel HD Semirigid uretero-rensoscopy with 45° angled ocular, Ø steps by 4.9 to 6.5 Fr., viewing angle 0°, working channel 1 x 3 Fr., 40.000 pixel
73 AA-007-022	425mm	HD Halbstarres Uretero-Renoskop mit 45° abgewinkeltem Okular, Ø stufenförmig 4.9 bis 6.5 Charr., Blickwinkel 5°, Arbeitskanal 1 x 3 Charr., 40.000 Pixel HD Semirigid uretero-rensoscopy with 45° angled ocular, Ø steps by 4.9 to 6.5 Fr., viewing angle 5°, working channel 1 x 3 Fr., 40.000 pixel
74 AA-007-023	425mm	HD Halbstarres Uretero-Renoskop mit 45° abgewinkeltem Okular, Ø stufenförmig 4.9 bis 6.5 Charr., Blickwinkel 12°, Arbeitskanal 1 x 3 Charr., 40.000 Pixel HD Semirigid uretero-rensoscopy with 45° angled ocular, Ø steps by 4.9 to 6.5 Fr., viewing angle 12°, working channel 1 x 3 Fr., 40.000 pixel
61 AA-007-007	310mm	HD Halbstarres Uretero-Renoskop mit 45° abgewinkeltem Okular, Ø stufenförmig 4.9 bis 6.5 Charr., Blickwinkel 0°, Arbeitskanal 1 x 3 Charr., 40.000 Pixel HD Semirigid uretero-rensoscopy with 45° angled ocular, Ø steps by 4.9 to 6.5 Fr., viewing angle 0°, working channel 1 x 3 Fr., 40.000 pixel
75 AA-007-024	310mm	HD Halbstarres Uretero-Renoskop mit 45° abgewinkeltem Okular, Ø stufenförmig 4.9 bis 6.5 Charr., Blickwinkel 5°, Arbeitskanal 1 x 3 Charr., 40.000 Pixel HD Semirigid uretero-rensoscopy with 45° angled ocular, Ø steps by 4.9 to 6.5 Fr., viewing angle 5°, working channel 1 x 3 Fr., 40.000 pixel
76 AA-007-025	310mm	HD Halbstarres Uretero-Renoskop mit 45° abgewinkeltem Okular, Ø stufenförmig 4.9 bis 6.5 Charr., Blickwinkel 12°, Arbeitskanal 1 x 3 Charr., 40.000 Pixel HD Semirigid uretero-rensoscopy with 45° angled ocular, Ø steps by 4.9 to 6.5 Fr., viewing angle 12°, working channel 1 x 3 Fr., 40.000 pixel
62 AA-007-008	150mm	HD Halbstarres Uretero-Renoskop mit 45° abgewinkeltem Okular, Ø stufenförmig 4.9 bis 6.5 Charr., Blickwinkel 0°, Arbeitskanal 1 x 3 Charr., 40.000 Pixel HD Semirigid uretero-rensoscopy with 45° angled ocular, Ø steps by 4.9 to 6.5 Fr., viewing angle 0°, working channel 1 x 3 Fr., 40.000 pixel
77 AA-007-026	150mm	HD Halbstarres Uretero-Renoskop mit 45° abgewinkeltem Okular, Ø stufenförmig 4.9 bis 6.5 Charr., Blickwinkel 5°, Arbeitskanal 1 x 3 Charr., 40.000 Pixel HD Semirigid uretero-rensoscopy with 45° angled ocular, Ø steps by 4.9 to 6.5 Fr., viewing angle 5°, working channel 1 x 3 Fr., 40.000 pixel
78 AA-007-027	150mm	HD Halbstarres Uretero-Renoskop mit 45° abgewinkeltem Okular, Ø stufenförmig 4.9 bis 6.5 Charr., Blickwinkel 12°, Arbeitskanal 1 x 3 Charr., 40.000 Pixel HD Semirigid uretero-rensoscopy with 45° angled ocular, Ø steps by 4.9 to 6.5 Fr., viewing angle 12°, working channel 1 x 3 Fr., 40.000 pixel

**Im Lieferumfang enthalten**  
**Delivery contains**

HD Uretero-Renoskop, Bürste Ø 3.0mm (Länge 590mm), Bürste Ø 3.8mm (Länge 350mm), Dichtungskappe Silikon (grau), Duckbill Dichtung  
HD uretero-rensoscopy, brush Ø 3.0mm (length 590mm), brush Ø 3.8mm (length 350mm), sealing cap silicone (grey), Duckbill sealing

**STEMA High Definition**



	<b>Bestell-Nr.</b> <b>Ordering no.</b>	<b>Arbeitslänge</b> <b>Working length</b>	
63	<b>AA-007-009</b>	425mm	HD Halbstarres Uretero-Renoskop mit 45° abgewinkeltem Okular, Ø stufenförmig 7.5 bis 13.2 Charr., Blickwinkel <b>0°</b> , Arbeitskanal 1 x 5 Charr. oder 2 x 3 Charr., 40.000 Pixel <i>HD Semirigid uretero-roscope with 45° angled ocular, Ø steps by 7.5 to 13.2 Fr., viewing angle <b>0°</b>, working channel 1 x 5 Fr. or 2 x 3 Fr., 40.000 pixel</i>
79	<b>AA-007-028</b>	425mm	HD Halbstarres Uretero-Renoskop mit 45° abgewinkeltem Okular, Ø stufenförmig 7.5 bis 13.2 Charr., Blickwinkel <b>5°</b> , Arbeitskanal 1 x 5 Charr. oder 2 x 3 Charr., 40.000 Pixel <i>HD Semirigid uretero-roscope with 45° angled ocular, Ø steps by 7.5 to 13.2 Fr., viewing angle <b>5°</b>, working channel 1 x 5 Fr. or 2 x 3 Fr., 40.000 pixel</i>
80	<b>AA-007-029</b>	425mm	HD Halbstarres Uretero-Renoskop mit 45° abgewinkeltem Okular, Ø stufenförmig 7.5 bis 13.2 Charr., Blickwinkel <b>12°</b> , Arbeitskanal 1 x 5 Charr. oder 2 x 3 Charr., 40.000 Pixel <i>HD Semirigid uretero-roscope with 45° angled ocular, Ø steps by 7.5 to 13.2 Fr., viewing angle <b>12°</b>, working channel 1 x 5 Fr. or 2 x 3 Fr., 40.000 pixel</i>

**Im Lieferumfang enthalten**  
**Delivery contains**



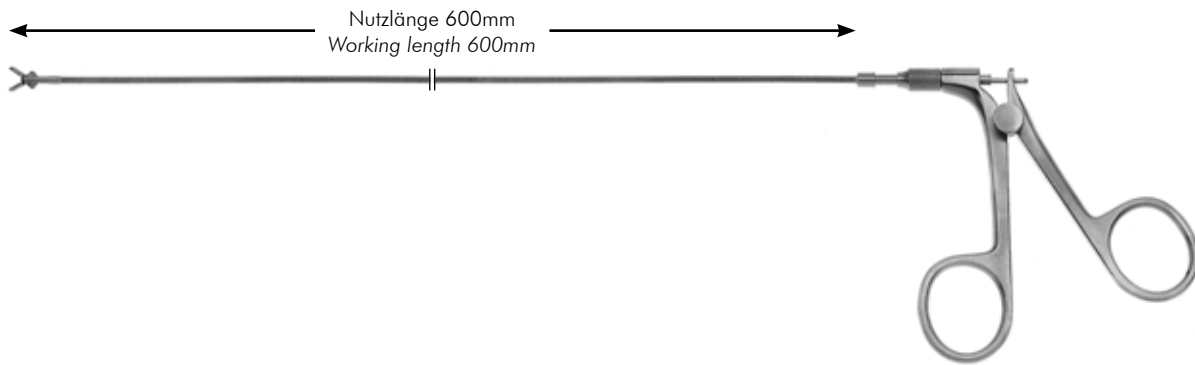

HD Uretero-Renoskop, Bürste Ø 3.0mm (Länge 590mm), Bürste Ø 3.8mm (Länge 350mm), Dichtungskappe Silikon (grau), Duckbill Dichtung  
*HD uretero-roscope, brush Ø 3.0mm (length 590mm), brush Ø 3.8mm (length 350mm), sealing cap silicone (grey), Duckbill sealing*



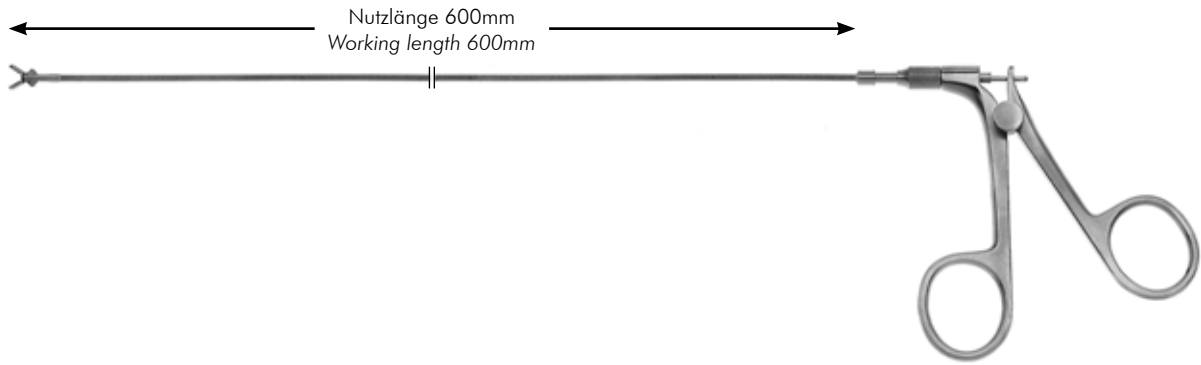







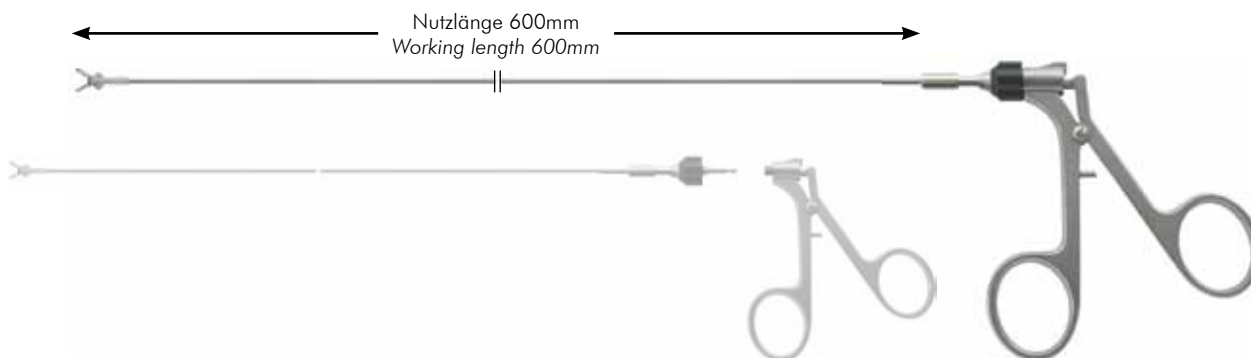



		Ømm	Charr. Fr.	Flexibel Flexible	Halbstarr Semi-rigid	Starr Rigid	
	Probeexzisionszange oval, doppelbeweglich <i>Biopsy forceps oval, double action</i>	1.0	3	257	AC-001-011293	AC-001-2113	AC-001-011-R
		1.6	5	261	AC-001-012296	AC-001-21226	AC-001-012-R
		2.1	6	265	AC-001-013299	AC-001-21326	AC-001-013-R
		2.3	7	267	AC-001-014300	AC-001-2146	AC-001-014-R
		3.0	9	271	AC-001-015203	AC-001-21526	AC-001-015-R
	Probeexzisionszange oval, gezahnt, doppelbeweglich <i>Biopsy forceps oval, serrated, double action</i>	1.0	3	318	AC-002-011	AC-002-211	AC-002-011-R
		1.6	5	319	AC-002-012330	AC-002-212320	AC-002-012-R
		2.1	6	321	AC-002-013331	AC-002-213	AC-002-013-R
		2.3	7	322	AC-002-014332	AC-002-2143	AC-002-014-R
		3.0	9	324	AC-002-015333	AC-002-21532	AC-002-015-R
	Probeexzisionszange oval, gezahnt, Zähne ineinandergreifend, doppelbeweglich <i>Biopsy forceps oval, serrated, teeth interlock, double action</i>	1.6	5	593	AC-015-012602	AC-015-212	AC-015-012-R
		2.1	6	595	AC-015-013603	AC-015-213594	AC-015-013-R
		2.3	7	596	AC-015-014604	AC-015-214597	AC-015-014-R
	Fremdkörperzange, doppelbeweglich <i>Grasping forceps for stone street, double action</i>	1.2	4	628	AC-017-011634	AC-017-211 <sup>9</sup>	AC-017-011-R
		2.3	7	630	AC-017-014635	AC-017-21463	AC-017-014-R
	Fasszange Alligatormaul, doppelbeweglich <i>Grasping forceps alligator jaw, double action</i>	1.0	3	465	AC-006-011501	AC-006-2115	AC-006-011-R
		1.2	4	473	AC-006-013507	AC-006-21347	AC-006-013-R
		1.6	5	469	AC-006-012504	AC-006-2124	AC-006-012-R
		2.3	7	477	AC-006-014510	AC-006-2141	AC-006-014-R
		3.0	9	481	AC-006-015513	AC-006-21547	AC-006-015-R
	Fasszange DJ, doppelbeweglich <i>Grasping forceps DJ, double action</i>	2.3	7	552	AC-008-014	AC-008-214556	AC-008-014-R
		3.0	9	553	AC-008-015	AC-008-215557	AC-008-015-R
	Fasszange gezahnt, doppelbeweglich <i>Grasping forceps teeth, double action</i>	1.2	4	614	AC-016-011622	AC-016-211616	AC-016-011-R
		1.6	5	618	AC-016-012623	AC-016-212620	AC-016-012-R
	Fasszange Zähne ineinander, doppelbeweglich <i>Grasping forceps teeth interlock, double action</i>	1.6	5	660	AC-020-012666	AC-020-212661	AC-020-012-R
		2.3	7	662	AC-020-014667	AC-020-214663	AC-020-014-R
	Fasszange Rattenzahn, doppelbeweglich <i>Grasping forceps rat tooth, double action</i>	1.0	3	646	AC-019-011653	AC-019-211647	AC-019-011-R
		1.6	5	648	AC-019-012654	AC-019-212649	AC-019-012-R
	Fasszange für Steinstrasse, doppelbeweglich <i>Grasping forceps for stone street, double action</i>	1.2	4	529	AC-007-011543	AC-007-211531	AC-007-011-R
		1.6	5	533	AC-007-012546	AC-007-212535	AC-007-012-R
	Fasszange für große Steine, doppelbeweglich <i>Grasping forceps for big stones, double action</i>	1.2	4	562	AC-009-011567	AC-009-211	AC-009-011-R
		1.6	5	563	AC-009-012568	AC-009-212	AC-009-012-R
		2.3	7	564	AC-009-014569	AC-009-214	AC-009-014-R
	Dreiarmsgreifer mit Griff <i>3-Prongs retriever with handle</i>	1.0	3	573	AC-012-011	AC-012-211	AC-012-011-R
		1.6	5	574	AC-012-012	AC-012-212	AC-012-012-R
		2.3	7	575	AC-012-014	AC-012-214	AC-012-014-R



		Ømm	Charr. Fr.	Flexibel Flexible	Halbstarr Semi-rigid	Starr Rigid
	Schere gezahnt, doppelbeweglich Scissors serrated, double action	2.3	7	441	AC-005-014444	AC-005-214442 AC-005-014-R
	Schere, einfachbeweglich Scissors, single action	1.0	3	358	AC-003-011396	AC-003-211360 AC-003-011-R
		1.2	4	354	AC-003-010393	AC-003-210356 AC-003-010-R
		1.6	5	362	AC-003-012399	AC-003-212364 AC-003-012-R
		2.1	6	366	AC-003-013402	AC-003-213364 AC-003-013-R
		2.3	7	367	AC-003-014403	AC-003-214369 AC-003-014-R
	Ureter-Schlitzschere, einfachbeweglich Uretero slitting scissors, single action	1.2	4		AC-018-211	AC-018-011-R
		1.6	5		AC-018-212636	AC-018-012-R
	Hakenschere, einfachbeweglich Hook scissors, single action	2.3	7	434	AC-004-014437	AC-004-214432 AC-004-014-R
		3.0	9	433	AC-004-015438	AC-004-215431 AC-004-015-R





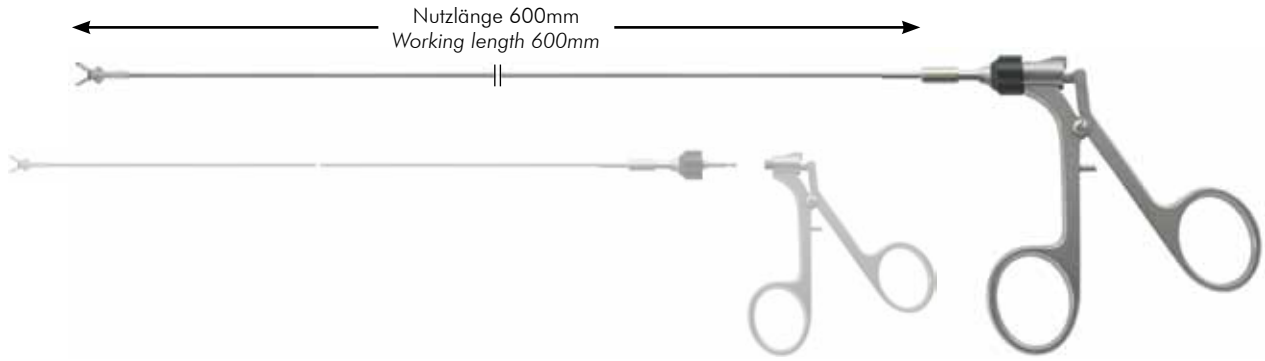



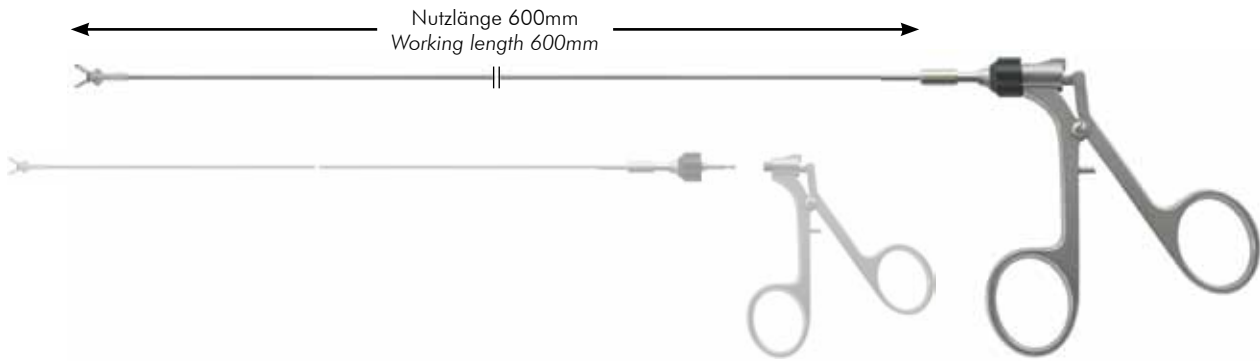

		Ømm	Charr. Fr.	Komplett Complete	Einsatz Insert	Griff Handle
 Probeexzisionszange oval, doppelbeweglich <i>Biopsy forceps oval, double action</i>	1.0	3	260	AC-001-011-T 258	AC-001-011-OT	AC-100-001
	1.2	4	256	AC-001-010-T 255	AC-001-010-OT	
	1.6	5	264	AC-001-012-T 262	AC-001-012-OT	
	2.3	7	270	AC-001-014-T 268	AC-001-014-OT	
	3.0	9	274	AC-001-015-T 272	AC-001-015-OT	
 Probeexzisionszange oval, gezahnt, doppelbeweglich <i>Biopsy forceps oval, serrated, double action</i>	1.2	4	617	AC-016-011-T 615	AC-016-011-OT	AC-100-001
	1.6	5	621	AC-016-012-T 619	AC-016-012-OT	
 Fasszange Alligatormaul, doppelbeweglich <i>Grasping forceps alligator jaw, double action</i>	1.0	3	468	AC-006-011-T 466	AC-006-011-OT	AC-100-001
	1.2	4	476	AC-006-013-T 474	AC-006-013-OT	
	1.6	5	472	AC-006-012-T 470	AC-006-012-OT	
	2.3	7	480	AC-006-014-T 478	AC-006-014-OT	
	3.0	9	484	AC-006-015-T 482	AC-006-015-OT	
 Fasszange für Steinstrasse, doppelbeweglich <i>Grasping forceps for stone street, double action</i>	1.2	4	532	AC-007-011-T 530	AC-007-011-OT	AC-100-001
	1.6	5	536	AC-007-012-T 534	AC-007-012-OT	
 Fasszange für große Steine, doppelbeweglich <i>Grasping forceps for big stones, double action</i>	1.2	4		AC-009-011-T	AC-009-011-OT	AC-100-001
	1.6	5		AC-009-012-T	AC-009-012-OT	
 Schere, einfachbeweglich <i>Scissors, single action</i>	1.0	3	357	AC-003-010-T 355	AC-003-010-OT	AC-100-001
	1.2	4	361	AC-003-011-T 359	AC-003-011-OT	
	1.6	5	365	AC-003-012-T 363	AC-003-012-OT	
	2.3	7	370	AC-003-014-T 368	AC-003-014-OT	
	3.0	9	374	AC-003-015-T 372	AC-003-015-OT	
 Schere spitz, einfachbeweglich <i>Scissors pointed, single action</i>	1.6	5	414	AC-003-412-T 413	AC-003-412-OT	AC-100-001
 Hakenschere, einfachbeweglich <i>Hook scissors, single action</i>	2.3	7		AC-004-014-T	AC-004-014-OT	AC-100-001
	3.0	9		AC-004-015-T	AC-004-015-OT	
 Biopsiestanze, einfachbeweglich <i>Biopsy punch forceps, single action</i>	1.6	5	579	AC-014-012-T 578	AC-014-012-OT	AC-100-001



		Ømm	Charr. Fr.	Komplett Complete	Einsatz Insert	Griff Handle
	Probeexzisionszange oval, doppelbeweglich <i>Biopsy forceps oval, double action</i>	1.0 1.2 1.6 2.3 3.0	3 4 5 7 9	AC-001-211-T 295 AC-001-210-T AC-001-212-T 298 AC-001-214-T 302 AC-001-215-T 305	AC-001-211-OT AC-001-210-OT AC-001-212-OT AC-001-214-OT AC-001-215-OT	AC-100-001
	Probeexzisionszange oval, gezahnt, doppelbeweglich <i>Biopsy forceps oval, serrated, double action</i>	1.2 1.6	4 5	AC-016-211-T AC-016-212-T	AC-016-211-OT AC-016-212-OT	AC-100-001
	Fasszange Alligatormaul, doppelbeweglich <i>Grasping forceps alligator jaw, double action</i>	1.0 1.2 1.6 2.3 3.0	3 503 4 509 5 506 7 512 9 515	AC-006-211-T 502 AC-006-213-T 508 AC-006-212-T 505 AC-006-214-T 511 AC-006-215-T 514	AC-006-211-OT AC-006-213-OT AC-006-212-OT AC-006-214-OT AC-006-215-OT	AC-100-001
	Fasszange für Steinstrasse, doppelbeweglich <i>Grasping forceps for stone street, double action</i>	1.2 1.6	4 545 5 548	AC-007-211-T 544 AC-007-212-T 547	AC-007-211-OT AC-007-212-OT	AC-100-001
	Fasszange für große Steine, doppelbeweglich <i>Grasping forceps for big stones, double action</i>	1.2 1.6	4 5	AC-009-211-T AC-009-212-T	AC-009-211-OT AC-009-212-OT	AC-100-001
	Schere, einfachbeweglich <i>Scissors, single action</i>	1.0 1.2 1.6 2.3 3.0	3 395 4 398 5 401 7 405 9 408	AC-003-210-T 394 AC-003-211-T 397 AC-003-212-T 400 AC-003-214-T 404 AC-003-215-T 407	AC-003-210-OT AC-003-211-OT AC-003-212-OT AC-003-214-OT AC-003-215-OT	AC-100-001
	Schere spitz, einfachbeweglich <i>Scissors pointed, single action</i>	1.6 2.3	5 7	AC-004-622-T AC-004-624-T	AC-004-622-OT AC-004-624-OT	AC-100-001
	Hakenschere, einfachbeweglich <i>Hook scissors, single action</i>	2.3 3.0	7 9	AC-004-214-T AC-004-215-T	AC-004-214-OT AC-004-215-OT	AC-100-001
	Biopsiestanze, einfachbeweglich <i>Biopsy punch forceps, single action</i>	1.6	5 583	AC-014-212-T 582	AC-014-212-OT	AC-100-001



		Ømm	Charr. Fr.	Komplett Complete	Einsatz Insert	Griff Handle
 <p>Probeexzisionszange oval, doppelbeweglich <i>Biopsy forceps oval, double action</i></p>	1.0	3	681	AC-101-211-T 680	AC-101-211-OT	AC-100-001
	1.2	4	679	AC-101-210-T 678	AC-101-210-OT	
	1.6	5	683	AC-101-212-T 682	AC-101-212-OT	
	2.3	7		AC-101-214-T	AC-101-214-OT	
	3.0	9	685	AC-101-215-T 684	AC-101-215-OT	
 <p>Probeexzisionszange oval, gezahnt, doppelbeweglich <i>Biopsy forceps oval, serrated, double action</i></p>	1.2	4	746	AC-116-211-T 745	AC-116-211-OT	AC-100-001
	1.6	5	748	AC-116-212-T 747	AC-116-212-OT	
 <p>Fasszange Alligatormaul, doppelbeweglich <i>Grasping forceps alligator jaw, double action</i></p>	1.0	3	722	AC-106-211-T 721	AC-106-211-OT	AC-100-001
	1.2	4	726	AC-106-213-T 725	AC-106-213-OT	
	1.6	5	724	AC-106-212-T 723	AC-106-212-OT	
	2.3	7	728	AC-106-214-T 727	AC-106-214-OT	
	3.0	9	730	AC-106-215-T 729	AC-106-215-OT	
 <p>Fasszange für Steinstrasse, doppelbeweglich <i>Grasping forceps for stone street, double action</i></p>	1.2	4	736	AC-107-211-T 735	AC-107-211-OT	AC-100-001
	1.6	5	738	AC-107-212-T 737	AC-107-212-OT	
 <p>Fasszange für große Steine, doppelbeweglich <i>Grasping forceps for big stones, double action</i></p>	1.2	4	742	AC-109-211-T 741	AC-109-211-OT	AC-100-001
	1.6	5		AC-109-212-T	AC-109-212-OT	
 <p>Schere, einfachbeweglich <i>Scissors, single action</i></p>	1.0	3	695	AC-103-210-T 694	AC-103-210-OT	AC-100-001
	1.2	4	697	AC-103-211-T 696	AC-103-211-OT	
	1.6	5	699	AC-103-212-T 698	AC-103-212-OT	
	2.3	7	701	AC-103-214-T 700	AC-103-214-OT	
	3.0	9	703	AC-103-215-T 702	AC-103-215-OT	
 <p>Schere spitz, einfachbeweglich <i>Scissors pointed, single action</i></p>	1.6	5		AC-104-622-T	AC-104-622-OT	AC-100-001
	2.3	7		AC-104-624-T	AC-104-624-OT	
 <p>Hakenschere, einfachbeweglich <i>Hook scissors, single action</i></p>	2.3	7	711	AC-104-214-T 710	AC-104-214-OT	AC-100-001
	3.0	9		AC-104-215-T 712	AC-104-215-OT	
 <p>Biopsiestanze, einfachbeweglich <i>Biopsy punch forceps, single action</i></p>	1.6	5		AC-114-212-T	AC-114-212-OT	AC-100-001



**Bestell-Nr.  
Ordering no.**

<b>AA-002-001</b>	Cystoskop Ø 4.0mm, Blickwinkel 0°, autoklavierbar <i>Cystoscope Ø 4.0mm, 0° viewing angle, autoclavable</i>
<b>AA-002-003</b>	Cystoskop Ø 4.0mm, Blickwinkel 30°, autoklavierbar <i>Cystoscope Ø 4.0mm, 30° viewing angle, autoclavable</i>
<b>AA-002-011</b>	<b>HD</b> Cystoskop Ø 4.0mm, Blickwinkel 0°, autoklavierbar <b>HD</b> <i>Cystoscope Ø 4.0mm, 0° viewing angle, autoclavable</i>
<b>AA-002-013</b>	<b>HD</b> Cystoskop Ø 4.0mm, Blickwinkel 30°, autoklavierbar <b>HD</b> <i>Cystoscope Ø 4.0mm, 30° viewing angle, autoclavable</i>



**Bestell-Nr.  
Ordering no.**      **Farbmarkierung  
Colour code**

144

<b>AB-002-010</b>	Blau <i>Blue</i>	Lithotripsieschaft mit Zentralhahn zur Benutzung mit AB-004-011 <i>Lithotripsy sheath with central valve used for AB-004-011</i>
-------------------	---------------------	---



**Bestell-Nr.  
Ordering no.**      **Farbmarkierung  
Colour code**

147

<b>AB-002-013</b>	Blau <i>Blue</i>	Lithotripsieschaft zur Benutzung mit AB-004-011 <i>Lithotripsy sheath used for AB-004-011</i>
-------------------	---------------------	--



**Bestell-Nr.  
Ordering no.**      **Farbmarkierung  
Colour code**

146

<b>AB-002-012</b>	Blau <i>Blue</i>	Obturator für AB-002-013 <i>Obturator for AB-002-013</i>
-------------------	---------------------	---



**Bestell-Nr.  
Ordering no.**      **Farbmarkierung  
Colour code**

145

<b>AB-002-011</b>	Blau <i>Blue</i>	Untersuchungseinsatz mit Arbeitskanal für flexible Instrumente 7 Charr. <i>Diagnostic sheath with with working channel for instruments 7 Fr.</i>
-------------------	---------------------	---



**Bestell-Nr.**  
**Ordering no.**

Blau  
Blue

Adpator zur Benutzung des Ellik  
*Adaptor for use with Ellik*

148

**AB-002-014**



**Bestell-Nr.**  
**Ordering no.**

Arbeitselement zur Punch-Lithotripsie  
*Working element used for punch lithotripsy*

176

**AB-004-011**



**Bestell-Nr.**  
**Ordering no.**

Mechanischer Lithotriptor mit Griff- und Schraubmechanismus, Ø 24 Charr., 2 Hähne mit Luer-Lock Adapter,  
zur Verwendung mit Optik AA-002-004  
*Mechanical lithotripter with handle and turning screw, Ø 24 Fr., 2 stopcocks with luer lock adapter,  
for use with scope AA-002-004*

177

**AB-004-012**

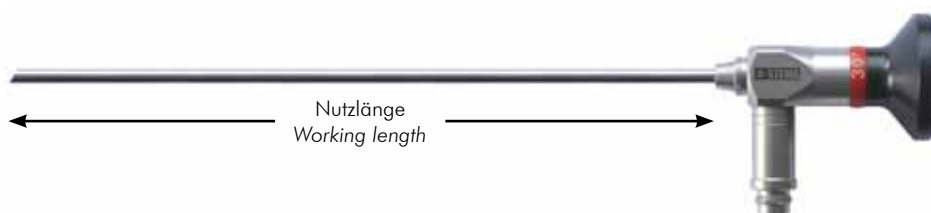

	<b>Bestell-Nr. Ordering no.</b>	<b>Durchmesser Diameter</b>	<b>Blickrichtung Direction of view</b>	<b>Farbmarkierung Colour code</b>	<b>Nutzlänge Working length</b>
30	<b>AA-004-013</b>	1.9mm	0°	Grün Green	145mm
31	<b>AA-004-014</b>	1.9mm	30°	Rot Red	145mm
28	<b>AA-004-011</b>	2.0mm	0°	Grün Green	187mm
29	<b>AA-004-012</b>	2.0mm	30°	Rot Red	187mm
26	<b>AA-004-001</b>	2.0mm	0°	Grün Green	260mm
27	<b>AA-004-002</b>	2.0mm	30°	Rot Red	260mm
32	<b>AA-005-001</b>	2.7mm	0°	Grün Green	187.5mm
33	<b>AA-005-003</b>	2.7mm	30°	Rot Red	187.5mm
34	<b>AA-005-004</b>	2.7mm	70°	Gelb Yellow	187.5mm





**Bestell-Nr.**  
**Ordering no.**

**AA-004-013**

Pädiatrie-Cystoskop Ø 1.9mm, Blickwinkel 0°, Arbeitslänge 145mm, autoklavierbar  
*Pediatric-Cystoscope Ø 1.9mm, 0° viewing angle, working length 145mm, autoclavable*

**AA-004-014**

Pädiatrie-Cystoskop Ø 1.9mm, Blickwinkel 30°, Arbeitslänge 145mm, autoklavierbar  
*Pediatric-Cystoscope Ø 1.9mm, 30° viewing angle, working length 145mm, autoclavable*



**Bestell-Nr.**  
**Ordering no.**

**Farbmarkierung**  
**Colour code**

112

**AB-001-001-7**

Gelb  
*Yellow*

Cysto-Urethroskopschaft 7.5 Ch. mit 2 starren Hähnen  
*Cysto-Urethroscope sheath 7.5 Fr. with 2 fixed stopcocks*



**Bestell-Nr.**  
**Ordering no.**

**Farbmarkierung**  
**Colour code**

123

**AB-001-011-7**

Gelb  
*Yellow*

Standardobturator für Cysto-Urethroskopschäfte 7.5 Charr.  
*Standardobturator Cysto-Urethroscope sheath 7.5 Fr.*



**Bestell-Nr.  
Ordering no.**

<b>AA-004-011</b>	Pädiatrie-Cystoskop Ø 2.0mm, Blickwinkel 0°, Arbeitslänge 187mm, autoklavierbar <i>Pediatric-Cystoscope Ø 2.0mm, 0° viewing angle, working length 187mm, autoclavable</i>
<b>AA-004-012</b>	Pädiatrie-Cystoskop Ø 2.0mm, Blickwinkel 30°, Arbeitslänge 187mm, autoklavierbar <i>Pediatric-Cystoscope Ø 2.0mm, 30° viewing angle, working length 187mm, autoclavable</i>



**Bestell-Nr.  
Ordering no.**      **Farbmarkierung  
Colour code**

113	<b>AB-001-001-9</b>	Blau <i>Blue</i>	Cysto-Urethroskopschaft 9.5 Ch. mit 2 starren Hähnen, 1 x 3 Ch. Instrumentenkanal, mit Obturator <i>Cysto-Urethroscope sheath 9.5 Fr. with 2 fixed stopcocks, 1 x 3 Fr. instrument channel, with obturator</i>
122	<b>AB-001-001-11</b>	Grün <i>Green</i>	Cysto-Urethroskopschaft 11 Ch. mit 2 starren Hähnen, 1 x 3 Ch. Instrumentenkanal, mit Obturator <i>Cysto-Urethroscope sheath 11 Fr. with 2 fixed stopcocks, 1 x 3 Fr. instrument channel, with obturator</i>



**Bestell-Nr.  
Ordering no.**      **Farbmarkierung  
Colour code**

124	<b>AB-001-011-9</b>	Blau <i>Blue</i>	Standardobturator für Cysto-Urethroskopschäfte 9.5 Charr. <i>Standardobturator Cysto-Urethroscope sheath 9.5 Fr.</i>
110	<b>AB-001-011-11</b>	Grün <i>Green</i>	Standardobturator für Cysto-Urethroskopschäfte 11 Charr. <i>Standardobturator Cysto-Urethroscope sheath 11 Fr.</i>



**Bestell-Nr.**  
**Ordering no.**

<b>AA-005-001</b>	Pädiatrie-Cystoskop Ø 2.7mm, Blickwinkel 0°, Arbeitslänge 187.5mm, autoklavierbar <i>Pediatric-Cystoscope Ø 2.7mm, 0° viewing angle, working length 187.5mm, autoclavable</i>
<b>AA-005-003</b>	Pädiatrie-Cystoskop Ø 2.7mm, Blickwinkel 30°, Arbeitslänge 187.5mm, autoklavierbar <i>Pediatric-Cystoscope Ø 2.7mm, 30° viewing angle, working length 187.5mm, autoclavable</i>
<b>AA-005-004</b>	Pädiatrie-Cystoskop Ø 2.7mm, Blickwinkel 70°, Arbeitslänge 187.5mm, autoklavierbar <i>Pediatric-Cystoscope Ø 2.7mm, 70° viewing angle, working length 187.5mm, autoclavable</i>



**Bestell-Nr.**  
**Ordering no.**

**Farbmarkierung**  
**Colour code**

109

<b>AB-001-001</b>	Rot <i>Red</i>	Cysto-Urethroskopschaft 13 Ch. mit 2 starren Hähnen, 1 x 3 Ch. Instrumentenkanal, mit Obturator <i>Cysto-Urethroscope sheath 13 Fr. with 2 fixed stopcocks, 1 x 3 Fr. instrument channel, with obturator</i>
-------------------	-------------------	---

111

<b>AB-001-001-13</b>	Rot <i>Red</i>	Cysto-Urethroskopschaft 13 Ch. mit 2 starren Hähnen, 1 x 5 Ch. oder 2 x 4 Ch. Instrumentenkanal, mit Obturator <i>Cysto-Urethroscope sheath 13 Fr. with 2 fixed stopcocks, 1 x 3 Fr. or 2 x 4 Fr. instrument channel, with obturator</i>
----------------------	-------------------	---



**Bestell-Nr.**  
**Ordering no.**

**Farbmarkierung**  
**Colour code**

121

<b>AB-001-011</b>	Rot <i>Red</i>	Standardobturator für Cysto-Urethroskopschäfte 13 Charr. <i>Standardobturator Cysto-Urethroscope sheath 13 Fr.</i>
-------------------	-------------------	---



**Bestell-Nr.**  
**Ordering no.**

153

<b>AB-003-005</b>	Arbeitseinsatz mit Albarranhebel, 13 Charr. <i>Working element with Albaran deflector, 13 Fr.</i>
-------------------	--



**Bestell-Nr.**  
**Ordering no.**

149

<b>AB-003-001</b>	Endoskopbrücke, 13 Charr. <i>Endoscope bridge, 13 Fr.</i>
-------------------	--

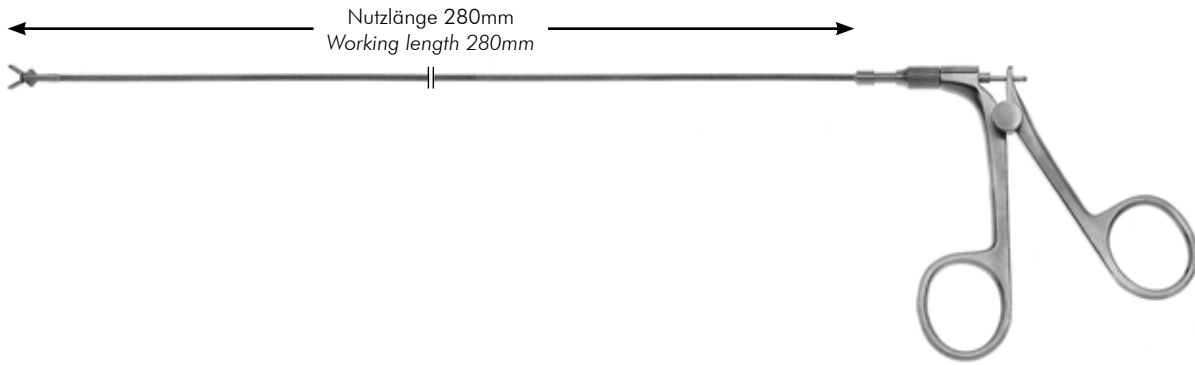

		Ømm	Charr. Fr.		Flexibel Flexible	Halbstarr Semi-rigid	
	Probeexzisionszange oval, doppelbeweglich Biopsy forceps oval, double action	1.0	3	275	AC-001-021	AC-001-221	306
	Fasszange Alligatormaul, doppelbeweglich Grasping forceps alligator jaw, double action	1.0	3	485	AC-006-021	AC-006-221	516
	Probeexzisionszange oval, gezahnt, Zähne ineinandergreifend, doppelbeweglich Biopsy forceps oval, serrated, teeth interlock, double action	1.0	3	598	AC-015-021	AC-015-221	605
	Fasszange Rattenzahn, doppelbeweglich Grasping forceps rat tooth, double action	1.0	3	650	AC-019-021	AC-019-221	655
	Schere, einfachbeweglich Scissors, single action	1.0	3	375	AC-003-021	AC-003-221	



Sonderlängen sowie isolierte flexible Modelle auf Anfrage erhältlich.  
 Special lengths as well as insulated flexible models available on request.





**Bestell-Nr.  
Ordering no.**

<b>AA-004-011</b>	Pädiatrie-Resektoskop Ø 2.0mm, Blickwinkel 0°, Arbeitslänge 187.5mm, autoklavierbar <i>Pediatric-resectoscope Ø 2.0mm, 0° viewing angle, working length 187.5mm, autoclavable</i>
<b>AA-005-001</b>	Pädiatrie-Resektoskop Ø 2.7mm, Blickwinkel 0°, Arbeitslänge 187.5mm, autoklavierbar <i>Pediatric-resectoscope Ø 2.7mm, 0° viewing angle, working length 187.5mm, autoclavable</i>



**Bestell-Nr.  
Ordering no.**      **Farbmarkierung  
Colour code**

952

<b>AH-005-001</b>	Blau <i>Blue</i>	Standard Resektoskopschaft 9 Charr. mit 1 drehbaren Hahn, ohne Obturator <i>Standard resectoscope sheath 9 Fr. with 1 rotatable stopcock, without obturator</i>
-------------------	---------------------	--

950

<b>AH-004-001</b>	Grün <i>Green</i>	Standard Resektoskopschaft 11 Charr. mit 1 drehbaren Hahn, ohne Obturator <i>Standard resectoscope sheath 11 Fr. with 1 rotatable stopcock, without obturator</i>
-------------------	----------------------	--

<b>AH-003-001</b>	Rot <i>Red</i>	Standard Resektoskopschaft 13 Charr. mit 1 drehbaren Hahn, ohne Obturator <i>Standard resectoscope sheath 13 Fr. with 1 rotatable stopcock, without obturator</i>
-------------------	-------------------	--



**Bestell-Nr.  
Ordering no.**      **Farbmarkierung  
Colour code**

953

<b>AH-005-011</b>	Blau <i>Blue</i>	Standardobturator für Resektoskopschaft 9 Charr. <i>Standard obturator for Resectoscopy sheath 9 Fr.</i>
-------------------	---------------------	---

951

<b>AH-004-011</b>	Grün <i>Green</i>	Standardobturator für Resektoskopschaft 11 Charr. <i>Standard obturator for Resectoscopy sheath 11 Fr.</i>
-------------------	----------------------	---

949

<b>AH-003-011</b>	Rot <i>Red</i>	Standardobturator für Resektoskopschaft 13 Charr. <i>Standard obturator for Resectoscopy sheath 13 Fr.</i>
-------------------	-------------------	---

**Für Endoskop  
For endoscope**

**Schaft  
Sheath**

**Durchmesser  
Diameter**

**Obturator  
Obturator**

<b>AA-004-011</b>	<b>AH-005-001</b>	9 Ch./Fr.	<b>AH-005-011</b>
<b>AA-004-011</b>	<b>AH-004-001</b>	11 Ch. / Fr.	<b>AH-004-011</b>
<b>AA-005-001</b>	<b>AH-003-001</b>	13 Ch. / Fr.	<b>AH-003-011</b>



**Bestell-Nr.**  
**Ordering no.**

977

**AI-003-003**

Endoskopbrücke, 13 Charr.  
*Endoscope bridge, 13 Fr.*



**Bestell-Nr.**  
**Ordering no.**

902

**AG-005-001**

Arbeitsinstrument für Pädiatrie-Resektoskope, passiv schneidend, Griff offen, 9 Charr.  
*Working element used for pediatric resectoscopes, passive cutting, handle open, 9 Fr.*

901

**AG-004-001**











Arbeitsinstrument für Pädiatrie-Resektoskope, passiv schneidend, Griff offen, 11 Charr.  
*Working element used for pediatric resectoscopes, passive cutting, handle open, 11 Fr.*

900

**AG-003-001**

Arbeitsinstrument für Pädiatrie-Resektoskope, passiv schneidend, Griff offen, 13 Charr.  
*Working element used for pediatric resectoscopes, passive cutting, handle open, 13 Fr.*



	<b>Bestell-Nr. Ordering no.</b>	<b>Charr. Fr.</b>	
	864 <b>AE-006-002</b>	9 (blau) 9 (blue)	Schlingenelektrode abgewinkelt Cutting loop electrode angled
	859 <b>AE-005-002</b>	11 (grün) 11 (green)	Schlingenelektrode abgewinkelt Cutting loop electrode angled
	854 <b>AE-004-002</b>	13 (rot) 13 (red)	Schlingenelektrode abgewinkelt Cutting loop electrode angled
	867 <b>AE-006-018</b>	9 (blau) 9 (blue)	Schlingenelektrode klein abgewinkelt Cutting loop electrode small angled
	862 <b>AE-005-018</b>	11 (grün) 11 (green)	Schlingenelektrode klein abgewinkelt Cutting loop electrode small angled
	857 <b>AE-004-018</b>	13 (rot) 13 (red)	Schlingenelektrode klein abgewinkelt Cutting loop electrode small angled
	865 <b>AE-006-004</b>	9 (blau) 9 (blue)	Ballelektrode gebogen Ball electrode curved
	860 <b>AE-005-004</b>	11 (grün) 11 (green)	Ballelektrode gebogen Ball electrode curved
	855 <b>AE-004-004</b>	13 (rot) 13 (red)	Ballelektrode gebogen Ball electrode curved
	866 <b>AE-006-016</b>	9 (blau) 9 (blue)	Messerelektrode abgewinkelt Knife electrode angled
	861 <b>AE-005-016</b>	11 (grün) 11 (green)	Messerelektrode abgewinkelt Knife electrode angled
	856 <b>AE-004-016</b>	13 (rot) 13 (red)	Messerelektrode abgewinkelt Knife electrode angled
	868 <b>AE-006-019</b>	9 (blau) 9 (blue)	Hakenelektrode ohne Kugel Hook electrode without ball
	863 <b>AE-005-019</b>	11 (grün) 11 (green)	Hakenelektrode ohne Kugel Hook electrode without ball
	858 <b>AE-004-019</b>	13 (rot) 13 (red)	Hakenelektrode ohne Kugel Hook electrode without ball



**Bestell-Nr.  
Ordering no.**

**AJ-010-006**

Schutzhülse aus Stahl zur Sterilisation und Aufbewahrung von Elektroden und Strikturmessern  
 Protection sleeve made of steel for sterilization and storage of electrodes and cold knives



**Bestell-Nr.  
Ordering no.**

<b>AA-004-011</b>	Pädiatrie-Cystoskop Ø 2.0mm, Blickwinkel 0°, Arbeitslänge 187.5mm, autoklavierbar <i>Pediatric-cystoscope Ø 2.0mm, 0° viewing angle, working length 187.5mm, autoclavable</i>
<b>AA-005-001</b>	Pädiatrie-Cystoskop Ø 2.7mm, Blickwinkel 0°, Arbeitslänge 187.5mm, autoklavierbar <i>Pediatric-cystoscope Ø 2.7mm, 0° viewing angle, working length 187.5mm, autoclavable</i>



**Bestell-Nr.  
Ordering no.**      **Farbmarkierung  
Colour code**

983	<b>AI-004-001</b>	Grün <i>Green</i>	Standard Urethrotomschaft 11 Charr. mit 2 starren Hähnen, mit Obturator <i>Standard urethrotome sheath 11 Fr. with 2 fixed stopcocks, with obturator</i>
976	<b>AI-003-001</b>	Rot <i>Red</i>	Standard Urethrotomschaft 13 Charr. mit 2 starren Hähnen, mit Obturator <i>Standard urethrotome sheath 13 Fr. with 2 fixed stopcocks, with obturator</i>







**Bestell-Nr.  
Ordering no.**      **Farbmarkierung  
Colour code**

984	<b>AI-004-004</b>	Grün <i>Green</i>	Standardobturator für Urethrotomschaft 11 Charr. <i>Standard obturator for urethrotome sheath 11 Fr.</i>
978	<b>AI-003-004</b>	Rot <i>Red</i>	Standardobturator für Urethrotomschaft 13 Charr. <i>Standard obturator for urethrotome sheath 13 Fr.</i>





	Bestell-Nr. Ordering no.	Charr. Fr.	
	985 <b>AI-004-007</b>	11 (grün) 11 (green)	Strikturmesser gerade Cold knife straight
	979 <b>AI-003-007</b>	13 (rot) 13 (red)	Strikturmesser gerade Cold knife straight
	986 <b>AI-004-009</b>	11 (grün) 11 (green)	Strikturmesser rund Cold knife round
	980 <b>AI-003-009</b>	13 (rot) 13 (red)	Strikturmesser rund Cold knife round
	987 <b>AI-004-010</b>	11 (grün) 11 (green)	Strikturmesser ringförmig Cold knife ring shaped
	981 <b>AI-003-010</b>	13 (rot) 13 (red)	Strikturmesser ringförmig Cold knife ring shaped
	988 <b>AI-004-011</b>	11 (grün) 11 (green)	Strikturmesser hakenförmig Cold knife hook shaped
	982 <b>AI-003-011</b>	13 (rot) 13 (red)	Strikturmesser hakenförmig Cold knife hook shaped



**Bestell-Nr.  
Ordering no.**

**AJ-010-006**

Schutzhülse aus Stahl zur Sterilisation und Aufbewahrung von Elektroden und Strikturmessern  
Protection sleeve made of steel for sterilization and storage of electrodes and cold knives

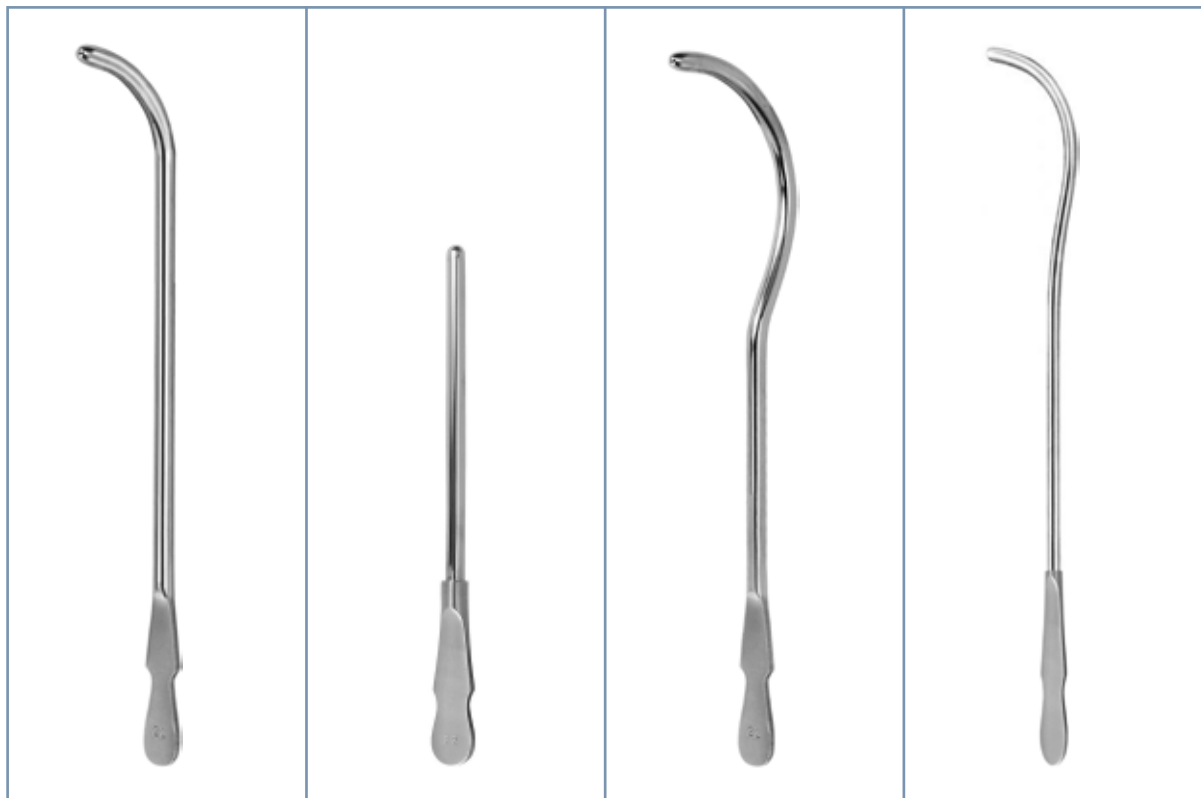

Van Buren  
Van Buren

Dittel, gerade  
Dittel, straight

Dittel, gebogen  
Dittel, curved

Guyon  
Guyon

Charr. Fr.	Bestell-Nr. Ordering no.	Bestell-Nr. Ordering no.	Bestell-Nr. Ordering no.	Bestell-Nr. Ordering no.
8	1007 AJ-003-001	1023 AJ-003-021	1049 AJ-003-050	1126 AJ-003-170
9		1024 AJ-003-022	1050 AJ-003-051	1127 AJ-003-171
10	1008 AJ-003-002	1025 AJ-003-023	1051 AJ-003-052	1128 AJ-003-172
11		1026 AJ-003-024	1052 AJ-003-053	1129 AJ-003-173
12	1009 AJ-003-003	1027 AJ-003-025	1053 AJ-003-054	1130 AJ-003-174
13		1028 AJ-003-026	1054 AJ-003-055	1131 AJ-003-175
14	1010 AJ-003-004	1029 AJ-003-027	1055 AJ-003-056	1132 AJ-003-176
15		1030 AJ-003-028	1056 AJ-003-057	1133 AJ-003-177
16	1011 AJ-003-005	1031 AJ-003-029	1057 AJ-003-058	1134 AJ-003-178
17		1032 AJ-003-030	1058 AJ-003-059	1135 AJ-003-179
18	1012 AJ-003-006	1033 AJ-003-031	1059 AJ-003-060	1136 AJ-003-180
19		1034 AJ-003-032	1060 AJ-003-061	1137 AJ-003-181
20	1013 AJ-003-007	1035 AJ-003-033	1061 AJ-003-062	1138 AJ-003-182
21		1036 AJ-003-034	1062 AJ-003-063	1139 AJ-003-183
22	1014 AJ-003-008	1037 AJ-003-035	1063 AJ-003-064	1140 AJ-003-184
23		1038 AJ-003-036	1064 AJ-003-065	1141 AJ-003-185
24	1015 AJ-003-009	1039 AJ-003-037	1063 AJ-003-066	1142 AJ-003-186
25		1040 AJ-003-038	1066 AJ-003-067	1143 AJ-003-187
26	1016 AJ-003-010	1041 AJ-003-039	1067 AJ-003-068	1144 AJ-003-188
27		1042 AJ-003-040	1068 AJ-003-069	1145 AJ-003-189
28	1017 AJ-003-011	1043 AJ-003-041	1069 AJ-003-070	1146 AJ-003-190
29		1044 AJ-003-042	1070 AJ-003-071	1147 AJ-003-191
30	1018 AJ-003-012	1045 AJ-003-043	1071 AJ-003-072	1148 AJ-003-192
31				1149 AJ-003-193
32	1019 AJ-003-013	1046 AJ-003-044	1072 AJ-003-074	1150 AJ-003-194
33				1151 AJ-003-195
34	1020 AJ-003-014	1047 AJ-003-045		1152 AJ-003-196
35				1153 AJ-003-197
36	1021 AJ-003-015	1048 AJ-003-046		1154 AJ-003-198
37				1155 AJ-003-199
38	1022 AJ-003-016			1156 AJ-003-200

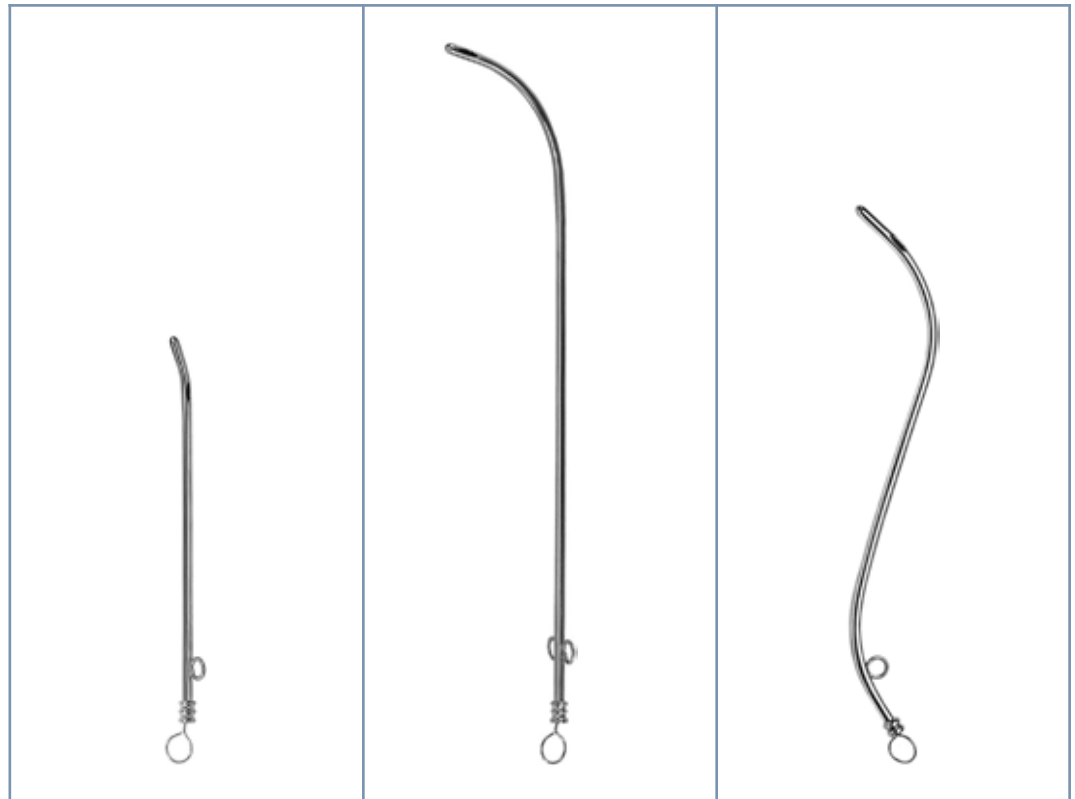

Für Männer <i>For men</i>	Für Frauen <i>For women</i>	Coxeter Prostata <i>Coxeter prostata</i>
------------------------------	--------------------------------	---

<b>Charr. Fr.</b>	<b>Bestell-Nr. Ordering no.</b>	<b>Bestell-Nr. Ordering no.</b>	<b>Bestell-Nr. Ordering no.</b>
<b>6</b>	<a href="#">1075</a> AJ-003-080	<a href="#">1094</a> AJ-003-100	
<b>7</b>	<a href="#">1075</a> AJ-003-081	<a href="#">1095</a> AJ-003-101	
<b>8</b>	<a href="#">1077</a> AJ-003-082	<a href="#">1096</a> AJ-003-102	<a href="#">1113</a> AJ-003-120
<b>9</b>	<a href="#">1078</a> AJ-003-083	<a href="#">1097</a> AJ-003-103	
<b>10</b>	<a href="#">1079</a> AJ-003-084	<a href="#">1098</a> AJ-003-104	<a href="#">1114</a> AJ-003-121
<b>11</b>	<a href="#">1080</a> AJ-003-085	<a href="#">1099</a> AJ-003-105	
<b>12</b>	<a href="#">1081</a> AJ-003-086	<a href="#">1100</a> AJ-003-106	<a href="#">1115</a> AJ-003-122
<b>13</b>	<a href="#">1082</a> AJ-003-087	<a href="#">1101</a> AJ-003-107	
<b>14</b>	<a href="#">1083</a> AJ-003-088	<a href="#">1102</a> AJ-003-108	<a href="#">1116</a> AJ-003-123
<b>15</b>	<a href="#">1084</a> AJ-003-089	<a href="#">1103</a> AJ-003-109	
<b>16</b>	<a href="#">1085</a> AJ-003-090	<a href="#">1104</a> AJ-003-110	<a href="#">1117</a> AJ-003-124
<b>17</b>	<a href="#">1086</a> AJ-003-091	<a href="#">1105</a> AJ-003-111	
<b>18</b>	<a href="#">1087</a> AJ-003-092	<a href="#">1106</a> AJ-003-112	<a href="#">1118</a> AJ-003-125
<b>19</b>	<a href="#">1088</a> AJ-003-093	<a href="#">1107</a> AJ-003-113	
<b>20</b>	<a href="#">1089</a> AJ-003-094	<a href="#">1108</a> AJ-003-114	<a href="#">1119</a> AJ-003-126
<b>21</b>	<a href="#">1090</a> AJ-003-095	<a href="#">1109</a> AJ-003-115	
<b>22</b>	<a href="#">1091</a> AJ-003-096	<a href="#">1110</a> AJ-003-116	<a href="#">1120</a> AJ-003-127
<b>23</b>	<a href="#">1092</a> AJ-003-097	<a href="#">1111</a> AJ-003-117	
<b>24</b>	<a href="#">1093</a> AJ-003-098	<a href="#">1112</a> AJ-003-118	<a href="#">1121</a> AJ-003-128



**Bestell-Nr.**  
**Ordering no.**



**AJ-003-142** 1124 Katheterspanner Guyon gerade, 39cm  
 Catheter introducer Guyon straight, 39cm



**AJ-003-143** 1125 Katheterspanner Guyon gebogen, 39cm  
 Catheter introducer Guyon curved, 39cm

**Bestell-Nr.**  
**Ordering no.**



**AJ-003-140** 1122 Penisklemme Stockmann, 8cm  
 Meatus clamp Stockmann, 8cm



**AJ-003-141** 1123 Penisklemme Strauss 11cm  
 Meatus clamp Strauss, 11cm



**Bestell-Nr.**  
**Ordering no.**



**AJ-006-012** Sekretlöffel Guttman, 26.5cm  
 Secretion spoon Guttman, 26.5cm

**Bestell-Nr.**  
**Ordering no.**



**AJ-010-011** 1165 Luer-Lock Schlauchverbinder  
 Luer-Lock tubing connector



**AJ-010-012** Luer-Lock Schlauchverbinder mit Absperrhahn  
 Luer-Lock tubing connector with stopcock

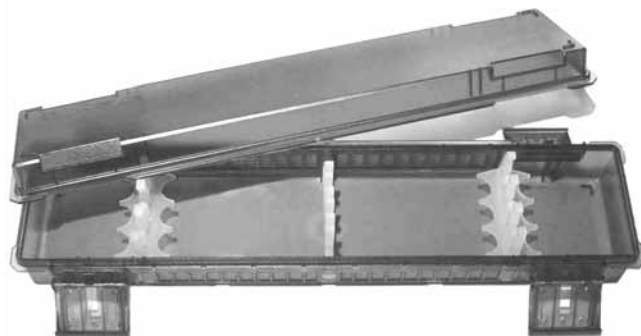

**Bestell-Nr.**  
**Ordering no.**

4060	<b>FA-020-001</b>	Endoskop-Container, Spezialkunststoff, Innenabmessungen 420 x 85 x 60mm (L x B x H) <i>Endoscope container, special plastic material, inner dimension 420 x 85 x 60mm (l x w x h)</i>
4061	<b>FA-020-010</b>	Silikoneinsatz für Endoskop-Container FA-020-001 (ohne Abbildung) <i>Silicone insert for endoscope container FA-020-001 (without illustration)</i>
4062	<b>FA-020-011</b>	Langzeitfilter für FA-020-001, 2 Stück (ohne Abbildung) <i>Long term filter for FA-020-001, 2 pieces (without illustration)</i>



# HYSTEROSKOPIE

# HYSTEROSCOPY



**Unsere Schäfte sind mit allen HD Optiken kompatibel**  
**Our sheaths are compatible with all HD scopes**



Bestell-Nr. Ordering no.	
<b>AA-004-001</b>	Hysteroskop Ø 2.0mm, Blickwinkel 0°, autoklavierbar, 260mm <i>Hysteroscope Ø 2.0mm, 0° viewing angle, autoclavable, 260mm</i>
<b>AA-004-002</b>	Hysteroskop Ø 2.0mm, Blickwinkel 30°, autoklavierbar, 260mm <i>Hysteroscope Ø 2.0mm, 30° viewing angle, autoclavable, 260mm</i>
<b>AA-001-001</b>	Hysteroskop Ø 2.7mm, Blickwinkel 0°, autoklavierbar, 302mm <i>Hysteroscope Ø 2.7mm, 0° viewing angle, autoclavable, 302mm</i>
<b>AA-001-003</b>	Hysteroskop Ø 2.7mm, Blickwinkel 30°, autoklavierbar, 302mm <i>Hysteroscope Ø 2.7mm, 30° viewing angle, autoclavable, 302mm</i>
<b>AA-003-001</b>	Hysteroskop Ø 2.9mm, Blickwinkel 0°, autoklavierbar, 302mm <i>Hysteroscope Ø 2.9mm, 0° viewing angle, autoclavable, 302mm</i>
<b>AA-003-002</b>	Hysteroskop Ø 2.9mm, Blickwinkel 30°, autoklavierbar, 302mm <i>Hysteroscope Ø 2.9mm, 30° viewing angle, autoclavable, 302mm</i>
<b>AA-002-001</b>	Hysteroskop Ø 4.0mm, Blickwinkel 0°, autoklavierbar, 302mm <i>Hysteroscope Ø 4.0mm, 0° viewing angle, autoclavable, 302mm</i>
<b>AA-002-002</b>	Hysteroskop Ø 4.0mm, Blickwinkel 12°, autoklavierbar, 302mm <i>Hysteroscope Ø 4.0mm, 12° viewing angle, autoclavable, 302mm</i>
<b>AA-002-003</b>	Hysteroskop Ø 4.0mm, Blickwinkel 30°, autoklavierbar, 302mm <i>Hysteroscope Ø 4.0mm, 30° viewing angle, autoclavable, 302mm</i>

**Schaffform /  
Shape of sheath**



**Schaft / Sheath**

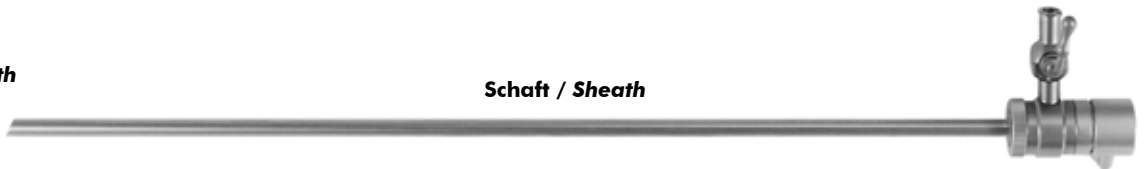

**Obturator / Obturator**



Für Endoskop For endoscope	Schaft Sheath	Durchmesser Diameter	Nutzlänge Working length	Obturator Obturator
<b>AA-002-001</b> <b>AA-002-002</b>	1203 <b>AN-003-001</b>	5.1mm	277mm	1205 <b>AN-003-003</b>
<b>AA-002-002</b> <b>AA-002-003</b>	1204 <b>AN-003-002</b>	5.1mm	277mm	<b>AN-003-003</b>
<b>AA-001-001</b> <b>AA-003-001</b>	1189 <b>AN-002-001</b>	3.7mm	277mm	<b>AN-002-003</b>
<b>AA-001-003</b> <b>AA-003-002</b>	1190 <b>AN-002-002</b>	3.7mm	277mm	<b>AN-002-003</b>
<b>AA-004-001</b>	1178 <b>AN-001-001</b>	2.5mm	235mm	<b>AN-001-003</b>
<b>AA-004-002</b>	1179 <b>AN-001-002</b>	2.5mm	235mm	<b>AN-001-003</b>

Unsere Schäfte sind mit allen HD Optiken kompatibel  
Our sheaths are compatible with all HD scopes



**Bestell-Nr.  
Ordering no.**

<b>AA-004-001</b>	Hysteroskop Ø 2.0mm, Blickwinkel 0°, autoklavierbar, 260mm Hysteroscope Ø 2.0mm, 0° viewing angle, autoclavable, 260mm
<b>AA-004-002</b>	Hysteroskop Ø 2.0mm, Blickwinkel 30°, autoklavierbar, 260mm Hysteroscope Ø 2.0mm, 30° viewing angle, autoclavable, 260mm
<b>AA-001-001</b>	Hysteroskop Ø 2.7mm, Blickwinkel 0°, autoklavierbar, 302mm Hysteroscope Ø 2.7mm, 0° viewing angle, autoclavable, 302mm
<b>AA-001-003</b>	Hysteroskop Ø 2.7mm, Blickwinkel 30°, autoklavierbar, 302mm Hysteroscope Ø 2.7mm, 30° viewing angle, autoclavable, 302mm
<b>AA-003-001</b>	Hysteroskop Ø 2.9mm, Blickwinkel 0°, autoklavierbar, 302mm Hysteroscope Ø 2.9mm, 0° viewing angle, autoclavable, 302mm
<b>AA-003-002</b>	Hysteroskop Ø 2.9mm, Blickwinkel 30°, autoklavierbar, 302mm Hysteroscope Ø 2.9mm, 30° viewing angle, autoclavable, 302mm
<b>AA-002-001</b>	Hysteroskop Ø 4.0mm, Blickwinkel 0°, autoklavierbar, 302mm Hysteroscope Ø 4.0mm, 0° viewing angle, autoclavable, 302mm
<b>AA-002-002</b>	Hysteroskop Ø 4.0mm, Blickwinkel 12°, autoklavierbar, 302mm Hysteroscope Ø 4.0mm, 12° viewing angle, autoclavable, 302mm
<b>AA-002-003</b>	Hysteroskop Ø 4.0mm, Blickwinkel 30°, autoklavierbar, 302mm Hysteroscope Ø 4.0mm, 30° viewing angle, autoclavable, 302mm

**Schaftform /  
Shape of sheath**



**Innenschaft / Inner sheath**

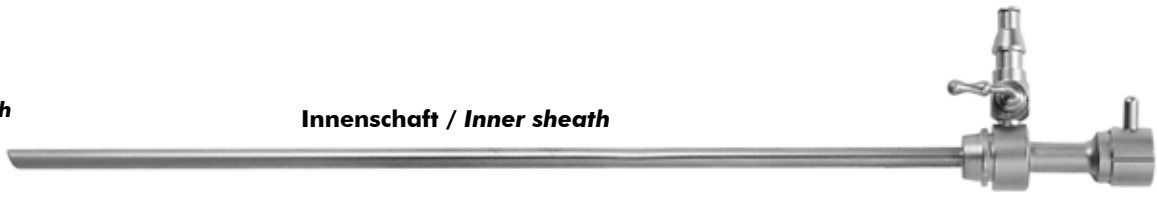

**Aussenschaft / Outer sheath**

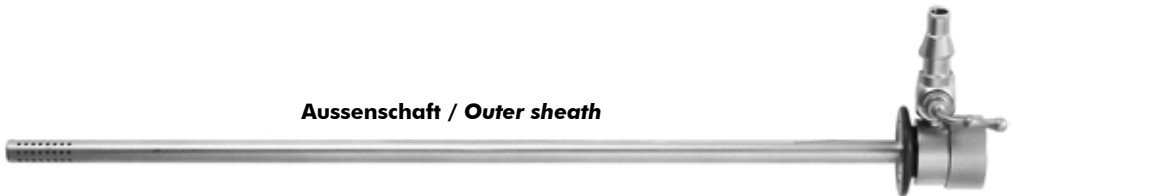

**Obturator / Obturator**



Für Endoskop For endoscope	Aussenschaft Ø / Nutzlänge Outer sheath Ø / Working length	Innenschaft Ø / Nutzlänge Inner sheath Ø / Working length	Obturator Obturator	Farbe Colour
<b>AA-002-001</b> <b>AA-002-002</b> 1208	<b>AN-003-103</b> 6.5mm / 246mm 1206	<b>AN-003-101</b> 5.4mm / 261mm 1209	<b>AN-003-104</b>	Blau Blue
<b>AA-002-002</b> <b>AA-002-003</b>	<b>AN-003-103</b> 6.5mm / 246mm 1207	<b>AN-003-102</b> 5.4mm / 261mm	<b>AN-003-104</b>	Blau Blue
<b>AA-001-001</b> <b>AA-003-001</b> 1194	<b>AN-002-103</b> 5.0mm / 246mm 1192	<b>AN-002-101</b> 3.7mm / 261mm 1195	<b>AN-002-104</b>	Weiß White
<b>AA-001-003</b> <b>AA-003-002</b>	<b>AN-002-103</b> 5.0mm / 246mm 1193	<b>AN-002-102</b> 3.7mm / 261mm	<b>AN-002-104</b>	Weiß White
<b>AA-004-001</b>	<b>AN-001-103</b> 3.4mm / 204mm 1181	<b>AN-001-101</b> 2.6mm / 219mm	<b>AN-001-104</b>	Rot Red
<b>AA-004-002</b> 1183	<b>AN-001-103</b> 3.4mm / 204mm 1182	<b>AN-001-102</b> 2.6mm / 219mm 1184	<b>AN-001-104</b>	Rot Red



**Unsere Schäfte sind mit allen HD Optiken kompatibel**  
**Our sheaths are compatible with all HD scopes**



Bestell-Nr. Ordering no.	
AA-001-001	Hysteroskop Ø 2.7mm, Blickwinkel 0°, autoklavierbar, 302mm Hysteroscope Ø 2.7mm, 0° viewing angle, autoclavable, 302mm
AA-001-003	Hysteroskop Ø 2.7mm, Blickwinkel 30°, autoklavierbar, 302mm Hysteroscope Ø 2.7mm, 30° viewing angle, autoclavable, 302mm
AA-003-001	Hysteroskop Ø 2.9mm, Blickwinkel 0°, autoklavierbar, 302mm Hysteroscope Ø 2.9mm, 0° viewing angle, autoclavable, 302mm
AA-003-002	Hysteroskop Ø 2.9mm, Blickwinkel 30°, autoklavierbar, 302mm Hysteroscope Ø 2.9mm, 30° viewing angle, autoclavable, 302mm
AA-002-001	Hysteroskop Ø 4.0mm, Blickwinkel 0°, autoklavierbar, 302mm Hysteroscope Ø 4.0mm, 0° viewing angle, autoclavable, 302mm
AA-002-002	Hysteroskop Ø 4.0mm, Blickwinkel 12°, autoklavierbar, 302mm Hysteroscope Ø 4.0mm, 12° viewing angle, autoclavable, 302mm
AA-002-003	Hysteroskop Ø 4.0mm, Blickwinkel 30°, autoklavierbar, 302mm Hysteroscope Ø 4.0mm, 30° viewing angle, autoclavable, 302mm

**Schaftform /  
Shape of sheath**



Für Endoskop For endoscope	Bestell-Nr. Ordering no.	Durchmesser Diameter	Durchlass Instrumentenkanal Capacity instrument channel	Nutzlänge Working length
AA-001-001 AA-003-001	1196 AN-002-201	6.0mm	5 Charr. 5 Fr.	193mm
AA-001-003 AA-003-002	1197 AN-002-202	6.0mm	5 Charr. 5 Fr.	193mm
AA-002-002 AA-002-001	1210 AN-003-201	8.0mm	7 Charr. 7 Fr.	193mm
AA-002-002 AA-002-003	1211 AN-003-202	8.0mm	7 Charr. 7 Fr.	193mm

**Unsere Schäfte sind mit allen HD Optiken kompatibel**  
**Our sheaths are compatible with all HD scopes**



**Bestell-Nr.**  
**Ordering no.**

**AA-002-003**

Hysteroskop Ø 4.0mm, Blickwinkel 30°, autoklavierbar, 302mm  
Hysteroscope Ø 4.0mm, 30° viewing angle, autoclavable, 302mm

**Schaftform /**  
**Shape of sheath**



**Arbeitseinsatz /**  
**Working element**



**Außenschaft / Outer sheath**

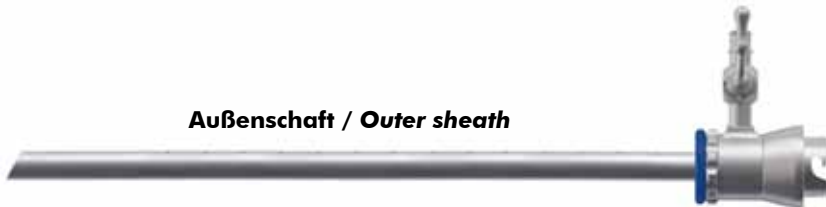

**Obturator / Obturator**

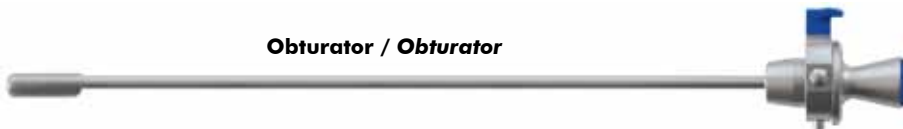

Für Endoskop For endoscope	Schaft Sheath	Durchmesser Diameter	Nutzlänge Working length	Arbeitseinsatz Working element	Obturator Obturator	Farbe Colour
AA-002-003	1213 AN-003-302	8.0mm	180mm	1212 AN-003-301	1214 AN-003-303	Blau Blue



**Unsere Schäfte sind mit allen HD Optiken kompatibel**  
**Our sheaths are compatible with all HD scopes**

Bestell-Nr. Ordering no.	
<b>AA-004-002</b>	Hysteroskop Ø 2.0mm, Blickwinkel 30°, autoklavierbar, 260mm Hysteroscope Ø 2.0mm, 30° viewing angle, autoclavable, 260mm
<b>AA-003-002</b>	Hysteroskop Ø 2.9mm, Blickwinkel 30°, autoklavierbar, 302mm Hysteroscope Ø 2.9mm, 30° viewing angle, autoclavable, 302mm
<b>AA-002-003</b>	Hysteroskop Ø 4.0mm, Blickwinkel 30°, autoklavierbar, 302mm Hysteroscope Ø 4.0mm, 30° viewing angle, autoclavable, 302mm

**Schaftform /  
Shape of sheath**



**Innenschaft / Inner sheath**

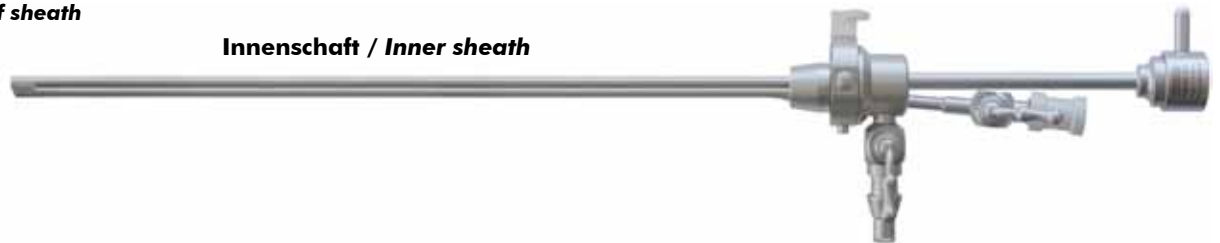

**Aussenschaft / Outer sheath**

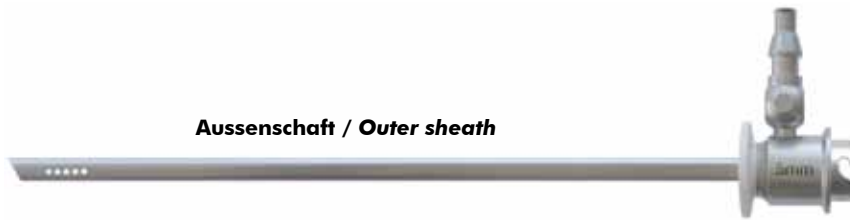

Für Endoskop For endoscope	Aussenschaft Outer sheath	Innenschaft Inner sheath	Ø Schaft Ø sheath	Arbeitskanal Working channel	Nutzlänge Working length	Farbe Colour
<b>AA-004-002</b> 1186	<b>AN-001-302</b> 1185	<b>AN-001-301</b>	4.3mm	5 Charr. 5 Fr.	181mm	Rot Red
<b>AA-003-002</b> <b>AA-003-012</b> 1199	<b>AN-002-302</b> 1198	<b>AN-002-301</b>	5.0mm	5 Charr. 5 Fr.	192mm	Weiß White
<b>AA-003-002</b> <b>AA-003-012</b> 1201	<b>AN-002-308</b> 1200	<b>AN-002-307</b>	6.3mm	9 Charr. 9 Fr.	192mm	Gelb Yellow
<b>AA-002-003</b> <b>AA-002-013</b> 1221	<b>AN-005-304</b> 1220	<b>AN-005-303</b>	7.0mm	7 Charr. 7 Fr.	192mm	Grün Green
<b>AA-002-003</b> <b>AA-002-013</b> 1219	<b>AN-005-302</b> 1218	<b>AN-005-301</b>	6.5mm	5 Charr. 5 Fr.	192mm	Blau Blue

**Unsere Schäfte sind mit allen HD Optiken kompatibel**  
**Our sheaths are compatible with all HD scopes**



**Bestell-Nr.**  
**Ordering no.**

<b>AA-002-001</b>	Hysteroskop Ø 4.0mm, Blickwinkel 0°, autoklavierbar, 302mm Hysteroscope Ø 4.0mm, 0° viewing angle, autoclavable, 302mm
<b>AA-002-002</b>	Hysteroskop Ø 4.0mm, Blickwinkel 12°, autoklavierbar, 302mm Hysteroscope Ø 4.0mm, 12° viewing angle, autoclavable, 302mm
<b>AA-002-003</b>	Hysteroskop Ø 4.0mm, Blickwinkel 30°, autoklavierbar, 302mm Hysteroscope Ø 4.0mm, 30° viewing angle, autoclavable, 302mm
<b>AA-002-004</b>	Hysteroskop Ø 4.0mm, Blickwinkel 70°, autoklavierbar, 302mm Hysteroscope Ø 4.0mm, 70° viewing angle, autoclavable, 302mm

**Schaftform /**  
**Shape of sheath**

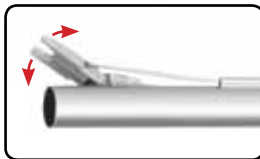

**Arbeitseinsatz /**  
**Working element**



**Aussenschaft / Outer sheath**

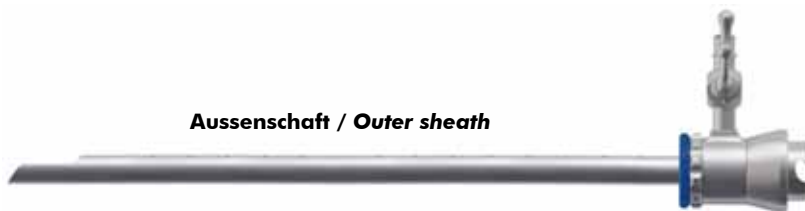

**Obturator / Obturator**

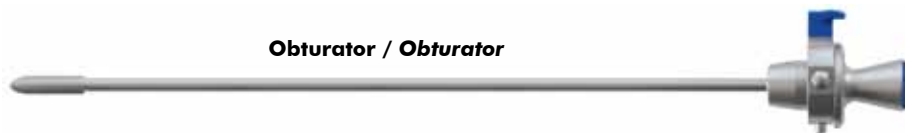

Für Endoskop For endoscope	Schaft Sheath	Durchmesser Diameter	Nutzlänge Working length	Arbeitseinsatz Working element	Obturator Obturator	Farbe Colour
AA-002-001 AA-002-002 AA-002-003 AA-002-004	1215 AN-004-401	8.0mm	180mm	1216 AN-004-402	1217 AN-004-403	Blau Blue



**Bestell-Nr.**  
**Ordering no.**

**Farbmarkierung**  
**Colour code**

1187

**AN-001-310**

Rot  
Red

HIGH-FLOW OP-Dauerspül-Hysteroskopschaft **Ø 4.3mm**, für 5 Ch. flexible und halbstarre Instrumente zur Verwendung mit 2.0mm Optiken (12° und 30°), Einschafsystem  
*HIGH-FLOW OP-Continuous-flow-hysteroscope sheath **Ø 4.3mm**, for 5 Fr. flexible and semirigid instruments for use with 2.0mm scopes (12° and 30°), single sheath system*

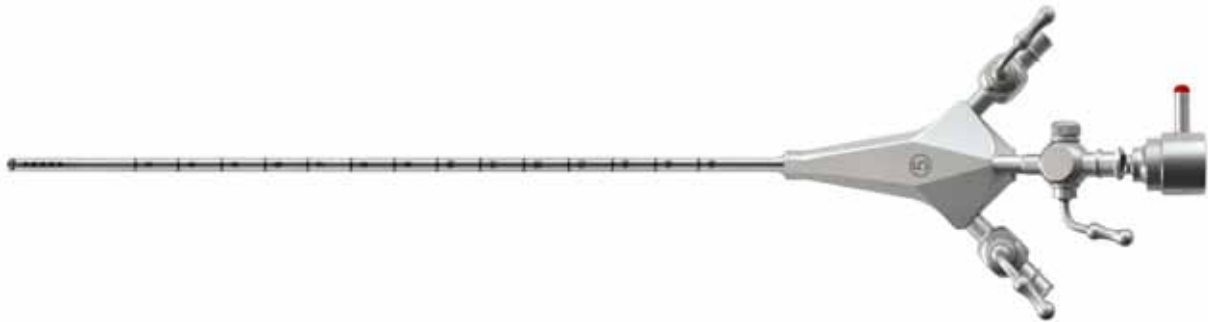

**Bestell-Nr.**  
**Ordering no.**

**Farbmarkierung**  
**Colour code**

1188

**AN-001-311**

Rot  
Red

HIGH-FLOW OP-Dauerspül-Hysteroskopschaft **Ø 4.3mm**, für 5 Ch. flexible und halbstarre Instrumente zur Verwendung mit 2.0mm Optiken (12° und 30°), Einschafsystem mit Absperrhahn  
*HIGH-FLOW OP-Continuous-flow-hysteroscope sheath **Ø 4.3mm**, for 5 Fr. flexible and semirigid instruments for use with 2.0mm scopes (12° and 30°), single sheath system with stopcock*



**Bestell-Nr.**  
**Ordering no.**

**Farbmarkierung**  
**Colour code**

**AN-002-310**

Weiss  
 White

HIGH-FLOW OP-Dauerspül-Hysteroskopschaft **Ø 5.5mm**, für 5 Ch. flexible und halbstarre Instrumente zur Verwendung mit 2.9mm Optiken (12° und 30°), Einschafsystem  
 HIGH-FLOW OP-Continuous-flow-hysteroscope sheath **Ø 5.5mm**, for 5 Fr. flexible and semirigid instruments for use with 2.9mm scopes (12° and 30°), single sheath system

1202



**Bestell-Nr.**  
**Ordering no.**

**Farbmarkierung**  
**Colour code**

**AN-002-311**



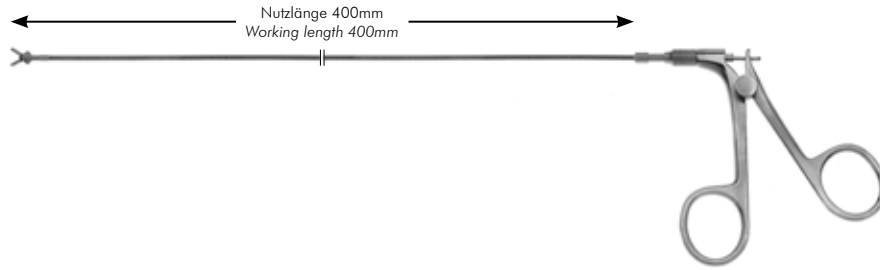

Weiss  
 White

HIGH-FLOW OP-Dauerspül-Hysteroskopschaft **Ø 5.5mm**, für 5 Ch. flexible und halbstarre Instrumente zur Verwendung mit 2.9mm Optiken (12° und 30°), Einschafsystem mit Absperrhahn  
 HIGH-FLOW OP-Continuous-flow-hysteroscope sheath **Ø 5.5mm**, for 5 Fr. flexible and semirigid instruments for use with 2.9mm scopes (12° and 30°), single sheath system with stopcock



	<b>Bestell-Nr.</b> <b>Ordering no.</b>	<b>Arbeitslänge</b> <b>Working length</b>	<b>Ømm</b>	
	<b>AC-001-502</b> 307	340mm	1.6	Probeexzisionszange oval, doppelbeweglich, starr <i>Biopsy forceps oval, double action, rigid</i>
	<b>AC-001-512</b> 309	410mm	1.6	Probeexzisionszange oval, doppelbeweglich, starr <i>Biopsy forceps oval, double action, rigid</i>
	<b>AC-001-504</b> 308	340mm	2.3	Probeexzisionszange oval, doppelbeweglich, starr <i>Biopsy forceps oval, double action, rigid</i>
	<b>AC-001-514</b> 310	410mm	2.3	Probeexzisionszange oval, doppelbeweglich, starr <i>Biopsy forceps oval, double action, rigid</i>
	<b>AC-002-502</b>	340mm	1.6	Probeexzisionszange oval, gezahnt, doppelbeweglich, starr <i>Biopsy forceps oval, serrated, double action, rigid</i>
	<b>AC-002-512</b>	410mm	1.6	Probeexzisionszange oval, gezahnt, doppelbeweglich, starr <i>Biopsy forceps oval, serrated, double action, rigid</i>
	<b>AC-010-502</b>	340mm	1.6	Probeexzisionszange oval, gezahnt, einfachbeweglich, starr <i>Biopsy forceps oval, serrated, single action, rigid</i>
	<b>AC-010-512</b>	410mm	1.6	Probeexzisionszange oval, gezahnt, einfachbeweglich, starr <i>Biopsy forceps oval, serrated, single action, rigid</i>
	<b>AC-010-504</b>	340mm	2.3	Probeexzisionszange oval, gezahnt, einfachbeweglich, starr <i>Biopsy forceps oval, serrated, single action, rigid</i>
	<b>AC-010-514</b>	410mm	2.3	Probeexzisionszange oval, gezahnt, einfachbeweglich, starr <i>Biopsy forceps oval, serrated, single action, rigid</i>
	<b>AC-014-502</b> 584	340mm	1.6	Biopsiestanze, einfachbeweglich <i>Biopsy punch forceps, single action</i>
	<b>AC-014-512</b> 586	410mm	1.6	Biopsiestanze, einfachbeweglich <i>Biopsy punch forceps, single action</i>
	<b>AC-014-504</b> 585	340mm	2.3	Biopsiestanze, einfachbeweglich <i>Biopsy punch forceps, single action</i>
	<b>AC-014-514</b> 587	410mm	2.3	Biopsiestanze, einfachbeweglich <i>Biopsy punch forceps, single action</i>
	<b>AC-006-502</b> 517	340mm	1.6	Fasszange Alligatormaul, doppelbeweglich, starr <i>Grasping forceps alligator jaw, double action, rigid</i>
	<b>AC-006-512</b> 519	410mm	1.6	Fasszange Alligatormaul, doppelbeweglich, starr <i>Grasping forceps alligator jaw, double action, rigid</i>
	<b>AC-006-504</b> 518	340mm	2.3	Fasszange Alligatormaul, doppelbeweglich, starr <i>Grasping forceps alligator jaw, double action, rigid</i>
	<b>AC-006-514</b> 520	410mm	2.3	Fasszange Alligatormaul, doppelbeweglich, starr <i>Grasping forceps alligator jaw, double action, rigid</i>
	<b>AC-003-502</b> 415	340mm	1.6	Schere, einfachbeweglich <i>Scissors, single action</i>
	<b>AC-003-512</b> 417	410mm	1.6	Schere, einfachbeweglich <i>Scissors, single action</i>
	<b>AC-003-504</b> 416	340mm	2.3	Schere, einfachbeweglich <i>Scissors, single action</i>
	<b>AC-003-514</b> 418	410mm	2.3	Schere, einfachbeweglich <i>Scissors, single action</i>
	<b>AC-003-602</b> 419	340mm	1.6	Schere spitz, einfachbeweglich <i>Scissors pointed, single action</i>
	<b>AC-003-612</b> 421	410mm	1.6	Schere spitz, einfachbeweglich <i>Scissors pointed, single action</i>
	<b>AC-003-604</b> 420	340mm	2.3	Schere spitz, einfachbeweglich <i>Scissors pointed, single action</i>
	<b>AC-003-614</b> 424	410mm	2.3	Schere spitz, einfachbeweglich <i>Scissors pointed, single action</i>



	Bestell-Nr. Ordering no.	Länge Length	Charr. Fr.	
	<b>AD-004-001</b>	<sup>781</sup> 360mm	5	Knopf-Elektrode flexibel, bipolar, Flachstecker <i>Button electrode flexible, bipolar, flat plug</i>
	<b>AD-004-002</b>	<sup>782</sup> 360mm	5	Nadel-Elektrode gewinkelt, flexibel, bipolar, Flachstecker <i>Needle electrode angled, flexible, bipolar, flat plug</i>
	<b>AD-004-003</b>	<sup>783</sup> 360mm	5	Nadel-Elektrode 90° gewinkelt, flexibel, bipolar, Flachstecker <i>Needle electrode 90° angled, flexible, bipolar, flat plug</i>
	<b>AD-004-004</b>	<sup>784</sup> 360mm	5	Nadel-Elektrode gerade, flexibel, bipolar, Flachstecker <i>Needle electrode straight, flexible, bipolar, flat plug</i>



Sonderlängen auf Anfrage erhältlich.  
Special lengths available on request.







**Bestell-Nr.**  
**Ordering no.**

<b>AM-002-020</b>	Uterusmanipulator komplett <i>Uterus manipulator complete</i>
<b>AM-002-021</b>	Handgriff drehbar <i>Handle rotatable</i>
<b>AM-002-022</b>	Spannschaft mit Überwurfhülse <i>Sheath with fixation nut</i>
<b>AM-002-023</b>	Innenrohr <i>Inner sheath</i>
<b>AM-002-024</b>	Schiebe- Fixationsschaft <i>Sliding and fixation sheath</i>
<b>AM-002-025</b>	Hülse 35mm <i>Tube 35mm</i>
<b>AM-002-026</b>	Hülse 40mm <i>Tube 40mm</i>
<b>AM-002-027</b>	Hülse 45mm <i>Tube 45mm</i>
<b>AM-002-028</b>	Cervix Krallenzange <i>Cervical tenaculum forceps</i>
<b>AM-002-029</b>	Intrauterin Adapter, 4 x 40mm <i>Intrauterin adapter, 4 x 40mm</i>
<b>AM-002-030</b>	Intrauterin Adapter, 5 x 50mm <i>Intrauterin adapter, 5 x 50mm</i>
<b>AM-002-031</b>	Intrauterin Adapter, 6 x 60mm <i>Intrauterin adapter, 6 x 60mm</i>
<b>AM-002-032</b>	Intrauterin Adapter, 7 x 70mm <i>Intrauterin adapter, 7 x 70mm</i>



**Bestell-Nr.**  
**Ordering no.**

<b>AM-004-001</b>	Ø 5mm Myomborher, Arbeitslänge 320mm <i>Ø 5mm myoma drill, working length 320mm</i>
<b>AM-004-002</b>	Ø 5mm Myomborher, Arbeitslänge 370mm <i>Ø 5mm myoma drill, working length 370mm</i>
<b>AM-004-003</b>	Ø 10mm Myomborher, Arbeitslänge 300mm <i>Ø 10mm myoma drill, working length 300mm</i>
<b>AM-004-004</b>	Ø 10mm Myomborher, Arbeitslänge 330mm <i>Ø 10mm myoma drill, working length 330mm</i>
<b>AM-004-005</b>	Ø 11mm Myomborher, Arbeitslänge 320mm <i>Ø 11mm myoma drill, working length 320mm</i>
<b>AM-004-006</b>	Ø 11mm Myomborher, Arbeitslänge 370mm <i>Ø 11mm myoma drill, working length 370mm</i>



**Bestell-Nr.**  
**Ordering no.**

- 1174 **AM-005-001** Ø 6mm Ringappikator für ersten Einstich, Arbeitslänge 328mm, komplett, zur Anwendung mit OP-Laparoskop  
Ø 6mm ring applicator for first incision, working length 328mm, complete, used with operating laparoscope



**Bestell-Nr.**  
**Ordering no.**

- 1175 **AM-005-002** Ø 6.5mm Ringappikator für zweiten Einstich, Arbeitslänge 288mm, komplett, zur Anwendung mit einer Trokarhülse  
Ø 6.5mm ring applicator for second incision, working length 288mm, complete, used with trocar sleeve



**AM-005-003**



**AM-005-004**

**Bestell-Nr.**  
**Ordering no.**

- 1176 **AM-005-003** Ladevorrichtung für Ringappikator  
Loading device for ring applicator
- 1177 **AM-005-004** Konusteil  
Conus piece



**AJ-005-001**



**AJ-005-002**

**Bestell-Nr.**  
**Ordering no.**

1147	<b>AJ-005-001</b>	Barret, Hakenzange, 18cm Barret, tenaculum forceps, 18cm
1148	<b>AJ-005-002</b>	Pozzi, Hakenzange, kräftiges Modell, 25.5cm Pozzi, tenaculum forceps, strong pattern, 25.5cm

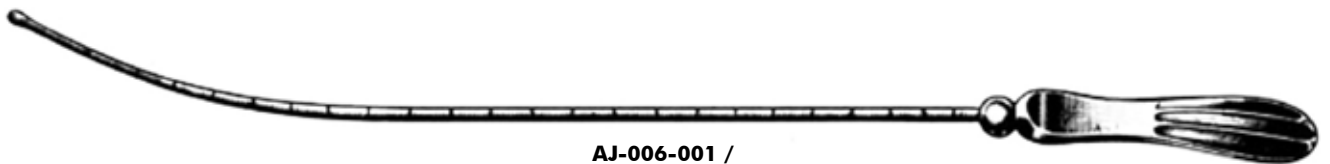

**AJ-006-001 /**  
**AJ-006-002**

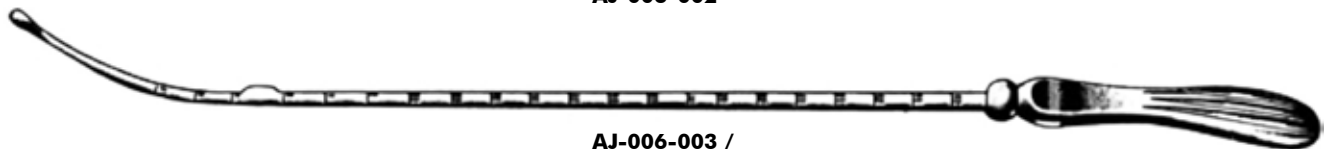

**AJ-006-003 /**  
**AJ-006-004**

**Bestell-Nr.**  
**Ordering no.**

<b>AJ-006-001</b>	Sims Uterussonde <b>starr</b> , 32cm Sims uterine probe <b>rigid</b> , 32cm
<b>AJ-006-002</b>	Sims Uterussonde <b>biegsam</b> , 32cm Sims uterine probe <b>malleable</b> , 32cm
<b>AJ-006-003</b>	Martin Uterussonde <b>starr</b> , 32cm Martin uterine probe <b>rigid</b> , 32cm
<b>AJ-006-004</b>	Martin Uterussonde <b>biegsam</b> , 32cm Martin uterine probe <b>malleable</b> , 32cm



**Bestell-Nr.  
Ordering no.**

1159	<b>AJ-006-005</b>	Novak Endometrium Biopsiekürette, Ø <b>1mm</b> , 23cm Novak endometrium biopsy curette, Ø <b>1mm</b> , 23cm
1160	<b>AJ-006-006</b>	Novak Endometrium Biopsiekürette, Ø <b>2mm</b> , 23cm Novak endometrium biopsy curette, Ø <b>2mm</b> , 23cm
1161	<b>AJ-006-007</b>	Novak Endometrium Biopsiekürette, Ø <b>3mm</b> , 23cm Novak endometrium biopsy curette, Ø <b>3mm</b> , 23cm
1162	<b>AJ-006-008</b>	Novak Endometrium Biopsiekürette, Ø <b>4mm</b> , 23cm Novak endometrium biopsy curette, Ø <b>4mm</b> , 23cm



**Bestell-Nr.  
Ordering no.**

1163	<b>AJ-006-012</b>	Guttman Sekretlöffel, 26.5cm Guttman secretion spoon, 26.5cm
------	-------------------	---



**Bestell-Nr.  
Ordering no.**

1073	<b>AJ-003-078</b>	Hegar Uterusdilatoren Set ( <b>8 Stück</b> ), doppelt, Ø 3/4mm - 17/18mm Hegar uterine dilatation set ( <b>8 pieces</b> ), double ended, Ø 3/4mm - 7/18mm
1074	<b>AJ-003-079</b>	Hegar Uterusdilatoren Set ( <b>13 Stück</b> ), doppelt, Ø 1/2mm - 25/26mm Hegar uterine dilatation set ( <b>13 pieces</b> ), double ended, Ø 1/2mm - 25/26mm



**Bestell-Nr.  
Ordering no.**

	<b>AM-003-001</b>	Portio Adapter <b>klein</b> , für Schaftdurchmesser Ø 8.5mm Portio cervix <b>small</b> , for sheath diameter Ø 8.5mm
	<b>AM-003-002</b>	Portio Adapter <b>groß</b> , für Schaftdurchmesser Ø 8.5mm Portio cervix <b>large</b> , for sheath diameter Ø 8.5mm

**AMBULANTES ATRAUMATISCHES OP-HYSTEROSKOPIE-SET**  
**OUT-PATIENT ATRAUMATIC OR HYSTEROSCOPY SET**

Komplettes Set bestehend aus:  
Complete set consisting of:

**Bestell-Nr.**  
**Ordering no.**

<b>AA-003-012</b>	<b>HD</b> Zystoskop Ø 2.9mm, Blickwinkel 30°, autoklavierbar <b>HD</b> Cystoscope Ø 2.9mm, 30° viewing angle, autoclavable
<b>AN-002-301</b>	Innen-OP-Dauerspül-Hysteroskopschaft für 5 Charr. flexible und halbstarre Instr. und für 2.7mm / 30° Optik, Ø 5.3mm <i>Inner-OR-continuous-flow-hysteroscope sheath for 5 Fr. flexible and semirigid instr. and for 2.7mm / 30° scopes, Ø 5.3mm</i>
<b>AN-002-302</b>	Aussen-OP-Dauerspül-Hysteroskopschaft für 5 Charr. flexible und halbstarre Instr. und für 2.7mm / 30° Optik, Ø 6.0mm <i>Outer-OR-continuous-flow-hysteroscope sheath for 5 Fr. flexible and semirigid instr. and for 2.7mm / 30° scopes, Ø 6.0mm</i>
<b>AC-002-002</b>	Probeexzisionszange oval gezahnt, flexibel, doppelbeweglich, Ø 1.6mm, AL 40cm <i>Biopsy forceps oval serrated, flexible, double action, Ø 1.6mm, WL 40cm</i>
<b>AC-003-102</b>	Schere flexibel, einfachbeweglich, isoliert, Ø 1.6mm, AL 40cm <i>Scissors flexible, single action, insulated, Ø 1.6mm, WL 40cm</i>
<b>AC-006-002</b>	Fasszange Alligatormaul, flexibel, doppelbeweglich, Ø 1.6mm, AL 40cm <i>Grasping forceps alligator jaw, flexible, double action, Ø 1.6mm, WL 40cm</i>
<b>AD-001-003</b>	Knopfelektrode flexibel, 5 Charr., monopolar, Länge 530mm <i>Button electrode flexible, 5 Fr., monopolar, length 530mm</i>
<b>AD-002-003</b>	Nadelelektrode flexibel, 5 Charr., monopolar, Länge 530mm <i>Needle electrode flexible, 5 Fr., monopolar, length 530mm</i>
<b>AF-002-002</b>	Diathermie Schlinge mit Tubus, Ø 1.6mm, komplett mit Griff, AL 50cm <i>Diathermy loop with tubus, 5 Fr., complete with handle, WL 50cm</i>

376



**CJ-010-016**

- Einfaches Einstellen
- Hohe Sicherheit verhindert Überdruck
- Permanente Patientenüberwachung
- Zugang vom sterilen Bereich

- Easy set up
- High safety avoids overpressure
- Cost-saving through efficiency
- Access from sterile field

**Bestell-Nr.**  
**Ordering no.**

**CG-001-011**

**Spül-Pumpe STEMA HYSTEROSKOPIE - Technische Daten**  
**Irrigation pump STEMA HYSTEROSCOPY - Technical data**

Spülleistung / Irrigation.....	30 - 500 ml/Min. / 30 - 500 ml/min.
Druckbereich / Pressure range .....	15 - 150 mmHg / 15 - 150 mmHg
Hochdruck-Schutz / High pressure safety.....	200 mmHg / 200 mmHg
Stromversorgung / Power supply.....	100 - 240 VAC, 50/60 Hz / 100 - 240 VAC, 50/60 Hz
Abmessungen / Dimensions .....	265 x 137 x 390mm (B x H x T) / 265 x 137 x 390mm (w x h x d)
Gewicht / Weight.....	4 kg / 4 kg
Klassifizierung / Classification .....	1/BF / 1/BF
Zertifikate / Certificates .....	CE, IEC 60601-1, EN 60601-1, 93/42 ECC / CE, IEC 60601-1, EN 60601-1, 93/42 ECC

**Im Lieferumfang enthalten**  
**Deliver contains**

Pumpe, Gebrauchsanweisung, Kabel: **ACHTUNG - Keine Anschlusskabel!** Diese müssen separat bestellt werden.  
Pump, operating manual, cable: **ATTENTION - No mains cable!** They need to be ordered separately.

**Bestell-Nr.**  
**Ordering no.**

2238	<b>CJ-010-001</b>	Silikon Schlauchset für CG-001-011, autoklavierbar, wiederverwendbar Silicone tubing set for CG-001-011, autoclavable, reusable
2239	<b>CJ-010-002</b>	PVC Schlauchset für CG-001-011 zum Einmalgebrauch, VE= 10 Stück PVC tubing set for CG-001-011, single use, pack=10 pieces
2240	<b>CJ-010-003</b>	PVC Schlauchset für CG-001-011 mit Sicherheitsverschluß zum Einmalgebrauch, VE=10 Stück PVC tubing set for CG-001-011 with safe lock, single use, 10 pieces
2245	<b>CJ-010-016</b>	Messstation für CG-001-011 Bottle scale used for CG-001-011
2246	<b>CJ-010-017</b>	PVC Schlauchset zum Einmalgebrauch (Ableitung), VE=10 Stück PVC tubing set (outflow), single use, pack=10 pieces
2247	<b>CJ-010-020</b>	Netzkabel 2m, EU Power supply cord 2m, EU
2248	<b>CJ-010-021</b>	Netzkabel 2m, UK Power supply cord 2m, UK
2249	<b>CJ-010-022</b>	Netzkabel 2m, US Power supply cord 2m, US